

HA11225

FM IF System

The HITACHI HA11225 is an FM IF Amplifier and Detector developed for HI FI Tuners. This IC is encapsulated in DIP-16 pin.

FUNCTIONS

- FM IF Amplifier
- Quadrature Detector
- Audio Amplifier
- Muting Circuit
- AFC, Tuning Meter Driver
- AGC Control Voltage Generator
- Muting Control Voltage Generator
- Signal Meter Driver

FEATURES

Many on-chip functions as above will result in smaller-sized sets, eliminate restriction in designing, and save labor.

- Low Distortion: 0.03% typ.
- High Signal-to-Noise Ratio: 84dB typ.
- High Limiting Sensitivity: 31dB μ typ.
- Large Muting Attenuation: 85 dB typ.
- Provides specific signal for direct drive of a signal meter with good linearity

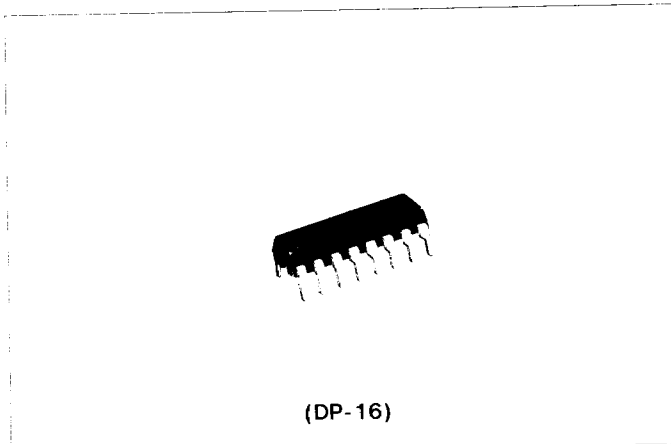

- Muting level is variable by adjusting the external resistor connected to pin 16.
- High stability against abnormal oscillation.

Note) 1. Testing conditions: Input=100dB μ , fm=400Hz, f=75kHz, fc=10.7MHz
 2. This IC is compatible with the HA1137W except pin 16 (pin for muting level adjustment).

BLOCK DIAGRAM

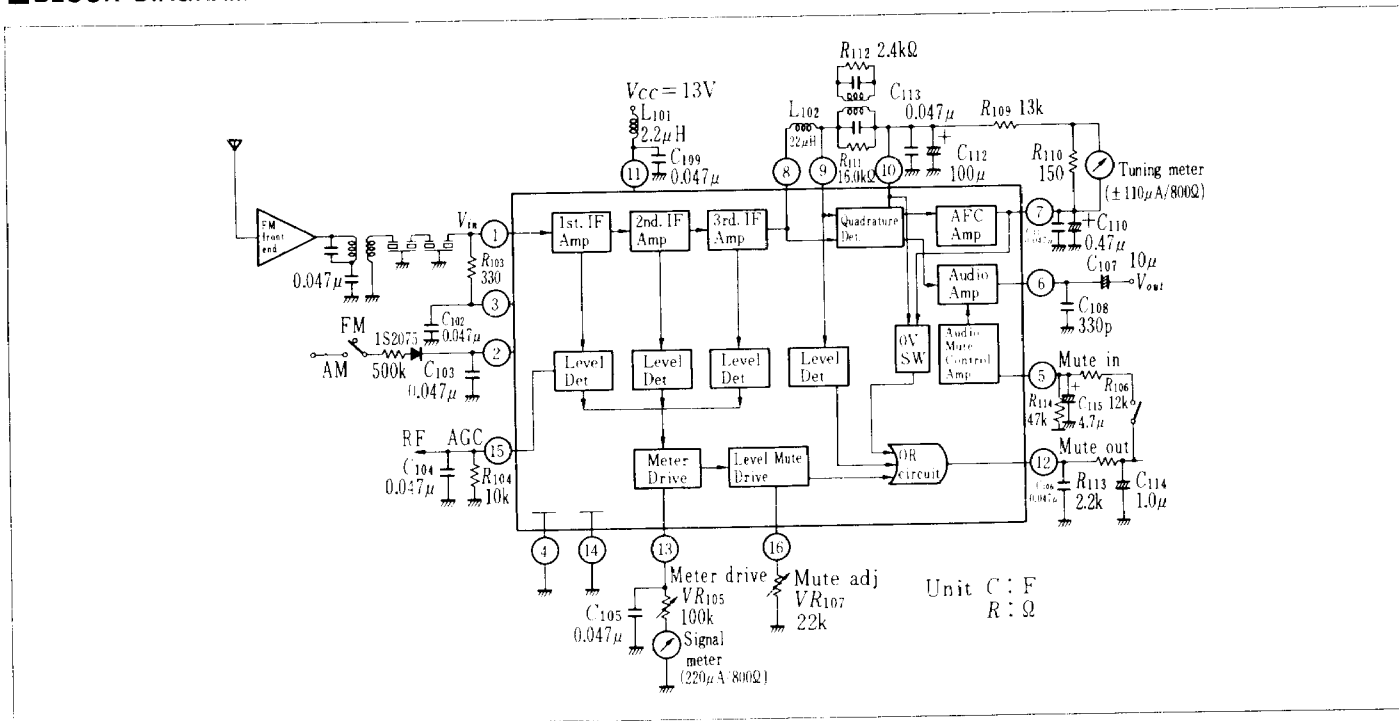

ABSOLUTE MAXIMUM RATINGS

Item	Symbol	Rating	Unit
Supply Voltage	V_{CC}	14	V
Power Dissipation*	P_T	590	mW
Operating Temperature	T_{opt}	-20 to +60	$^{\circ}C$
Storage Temperature	T_{stg}	-55 to +125	$^{\circ}C$

■ ELECTRICAL CHARACTERISTICS ($T_a=25^\circ\text{C}$)

● Static (DC) Characteristics ($V_{CC}=13\text{V}$, no signal)

Item	Symbol	Rating			Unit
		min.	typ.	max.	
Pin 1 Voltage	V_1	—	1.95	—	V
Pin 2 Voltage	V_2	—	1.95	—	V
Pin 3 Voltage	V_3	—	1.95	—	V
Pin 6 Voltage	V_6	—	5.60	—	V
Pin 7 Voltage	V_7	—	5.60	—	V
Pin 10 Voltage	V_{10}	—	5.60	—	V

● AC Characteristics ($V_{CC}=13\text{V}$, $f_c=10.7\text{MHz}$, $f_m=400\text{Hz}$, $\Delta f=75\text{kHz}$ dev.)

Item	Symbol	Test Condition	min.	typ.	max.	Unit
Supply Current	I_{CC}	$V_{in}=0\text{dB}\mu$, Pin 16 to Ground open	16	25	33	mA
Limiting Sensitivity	$V_{in}(\text{lim})$	$V_{in}=100\text{dB}\mu$ input, Input level -3dB from $V_{O(AF)}$	—	31	37	$\text{dB}\mu$
Recovered AF Voltage	$V_{O(AF)}$	$V_{in}=100\text{dB}\mu$	265	380	510	mVrms
Total Harmonic Distortion	T.H.D	$V_{in}=100\text{dB}\mu$	—	0.03	0.10	%
Signal-to-noise Ratio	S/N	$V_{in}=100\text{dB}\mu$	78	84	—	dB
AM Rejection Ratio	AMR	$V_{in}=100\text{dB}\mu$, AM : $f_m=1\text{kHz}$, Mod. 30%	45	54	—	dB
Muting Attenuation	Mute _(ATT)	$V_{in}=100\text{dB}\mu$, Output standard with pin 5 open, Attenuation with 2V impressed to pin 5	70	85	—	dB
Muting Bandwidth	BW (Mute)	$V_{in}=100\text{dB}\mu$, Sum of + and - side Δf for $V_{12}=1.4\text{V}$	55	105	145	kHz
Muting Sensitivity	V_{in} (Mute)	No muting level adjustment (pin 16 open), Input level for $V_{12}=1.4\text{V}$	36	44	60	$\text{dB}\mu$
Muting Sensitivity Adjustment Range	$AV_{in}(\text{Mute})^*$	Max. input level with possible muting level adjustment	75	—	—	$\text{dB}\mu$
Meter Drive Voltage (1)	V_{13-0}	$V_{in}=0\text{dB}\mu$, Pin 13 voltage	—	0	—	V
Meter Drive Voltage (2)	V_{13-70}	$V_{in}=70\text{dB}\mu$, Pin 13 voltage	0.9	1.45	—	V
Meter Drive Voltage (3)	V_{13-100}	$V_{in}=100\text{dB}\mu$, Pin 13 voltage	4.7	5.2	—	V
AGC Control Voltage	V_{15}	$V_{in}=86\text{dB}\mu$, Pin 15 voltage	—	4.3	—	V

* Muting level can be adjusted up to 75 $\text{dB}\mu$ and should be set within this range.

■ TEST CIRCUIT

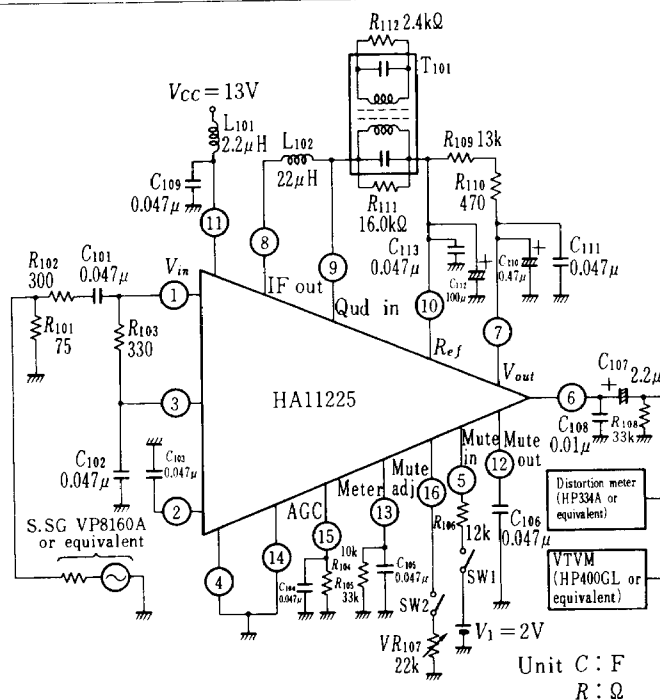

Notes :

1. SW₁ on when testing muting attenuation, off for other items.
2. SW₂ on when testing muting sensitivity adjustment range, off for other items.

Unit C : F
R : Ω

■ CHARACTERISTICS

The following characteristics have been achieved by giving careful consideration to the designing.

● FM IF Amp/Detector

Requirements for high performance FM tuners are satisfied by high S/N, low THD, and wide low-THD bandwidth.

The signal-to-noise ratio has reached 84dB typ; the HA11225 is designed for minimizing FM-demodulated noise (converted at the quadrature detector) and audible noise of the post stage audio amp.

Also, the optimized design in 90° phase-shift circuit has brought out low THD of 0.03% typ ($V_{in}=65\sim 120dB\mu$) and wide low-THD bandwidth of 10.7MHz±80kHz (THD=0.1%)

In contrast to the conventional ones, this IC has removed the pin-9 IF output signal detection used for muting. The detection independent muting operation can eliminate much restriction in designing a phase shift transformer.

● Audio Muting Section

Muting under weak-input or detuning is allowed by applying mute control voltage into pin-5 from pin-12.

Internal crosstalk of audio signal is minimized by connecting an external 100μF to pin-10 to obtain a large muting attenuation of 85dB typ. The 100μF capacitor also contributes to S/N improvement.

● Muting Control/Driver

Muting function starts at 44dB typ of input voltage when pin-16 is open (i.e., $R_{107}=\infty$). Therefore by simply changing an external resistor at pin-16, the mute starting point can be adjusted up to 75dBμ. This feature enables low noise stereo reception.

Even when the mute starting point is set variable by controlling VR_{107} (an external resistor at pin-16), the circuit will not cause any temperature dependent problems.

■ EXTERNAL COMPONENTS

Parts No.	Recommended Value	Purpose	Influence		Remarks
			Smaller than Recommended value	Larger than Recommended value	
R_{103}	330Ω	Impedance matching with ceramic filter	—	—	—
R_{104}	10kΩ	Normal operation of AGC	Increase in current consumption	—	—
VR_{105}	100kΩ	Adjustment of signal meter sensitivity	—	—	Semifixed resistor
R_{106}	12kΩ	Smoothing C_{115} and muting control voltage	Lower time constant	Larger time constant	Measure to reduce pop noise during muting (smooths waveform)
VR_{107}	22kΩ	Operation level of level muting	—	—	Semifixed resistor
R_{109}	13kΩ	Determination of size of AFC voltage and muting bandwidth	Lower AFC voltage, Wider muting bandwidth	Larger AFC voltage, Narrower muting bandwidth	R_{109} and C_{110} make up low pass filter. If R_{109} changes, C_{110} will also change so that $R_{109} \times C_{110}$ remains constant.
R_{110}	150Ω	Adjustment of tuning meter sensitivity	Drop in tuning meter sensitivity	Improved tuning meter sensitivity	—
R_{111}	16kΩ	Damping of phase shifter (primary side)	Increased T.H.D, Large voltage left in pin 12.	Increased T.H.D	—
R_{112}	2.4kΩ	Damping of phase shifter (secondary side)	Increased T.H.D	Increased T.H.D	—
R_{113}	2.2kΩ	Smoothing C_{114} and muting control voltage, Determination of muting (time constant)	Lower time constant	Larger time constant	For prevention of chattering of pin 12 voltage.
C_{102} C_{103}	0.047μF	Bypass capacitor	Poorer FM IF frequency stability	—	Use capacitor with good high frequency characteristics.
C_{104}	0.047μF	Smoothing of AGC voltage	IF frequency(10.7MHz) left in AGC voltage	—	—
C_{105}	0.047μF	Bypass capacitor	Increased T.H.D near meter response	—	—
C_{106}	0.047μF	Bypass capacitor	Poorer FM IF frequency stability	—	—
C_{107}	10μF	Coupling capacitor for detector output	Cut of low bands	—	—

(to be continued)

Parts No.	Recommended Value	Purpose	Influence		Remarks
			Smaller than Recommended value	Larger than Recommended value	
C ₁₀₈	330 pF	Bypass capacitor	High frequency pass of output pin 6 changes, oscillation must be checked	—	C ₁₀₈ =0.01 μF at test circuit
C ₁₀₉	0.047 μF × 2	Decoupling of L ₁₀₁ power supply	Reduced decoupling effect	—	—
C ₁₁₀	0.47 μF	Bypass capacitor (Low frequency)	—	Slower AFC voltage response	Use both C ₁₁₀ and C ₁₁₁
C ₁₁₁	0.047 μF	Bypass capacitor (High frequency)	—	—	
C ₁₁₂	100 μF	Bypass capacitor (Low frequency)	Poorer S/N	Deterioration of IC by large current flowing when charging	—
C ₁₁₃	0.047 μF	Bypass capacitor (High frequency)	—	—	—
C ₁₁₄	1.0 μF	Smoothing R ₁₁₃ and muting control voltage	Error in muting by AC part of muting control voltage	Slower muting response	—
C ₁₁₅	4.7 μF	Smoothing R ₁₀₆ and muting control voltage	Error in muting by AC part of muting control voltage	Slower muting response	—
L ₁₀₁	2.2 μH	Decoupling C ₁₁₅ and power supply	—	—	Use one with good high frequency characteristics. Note vibration stability.
L ₁₀₂	22 μH	Detector phase shifter coil	Normal detector characteristics not obtained, Large voltage left in pin 12	Normal detector characteristics not obtained	—

■ PC-BOARD LAYOUT PATTERN

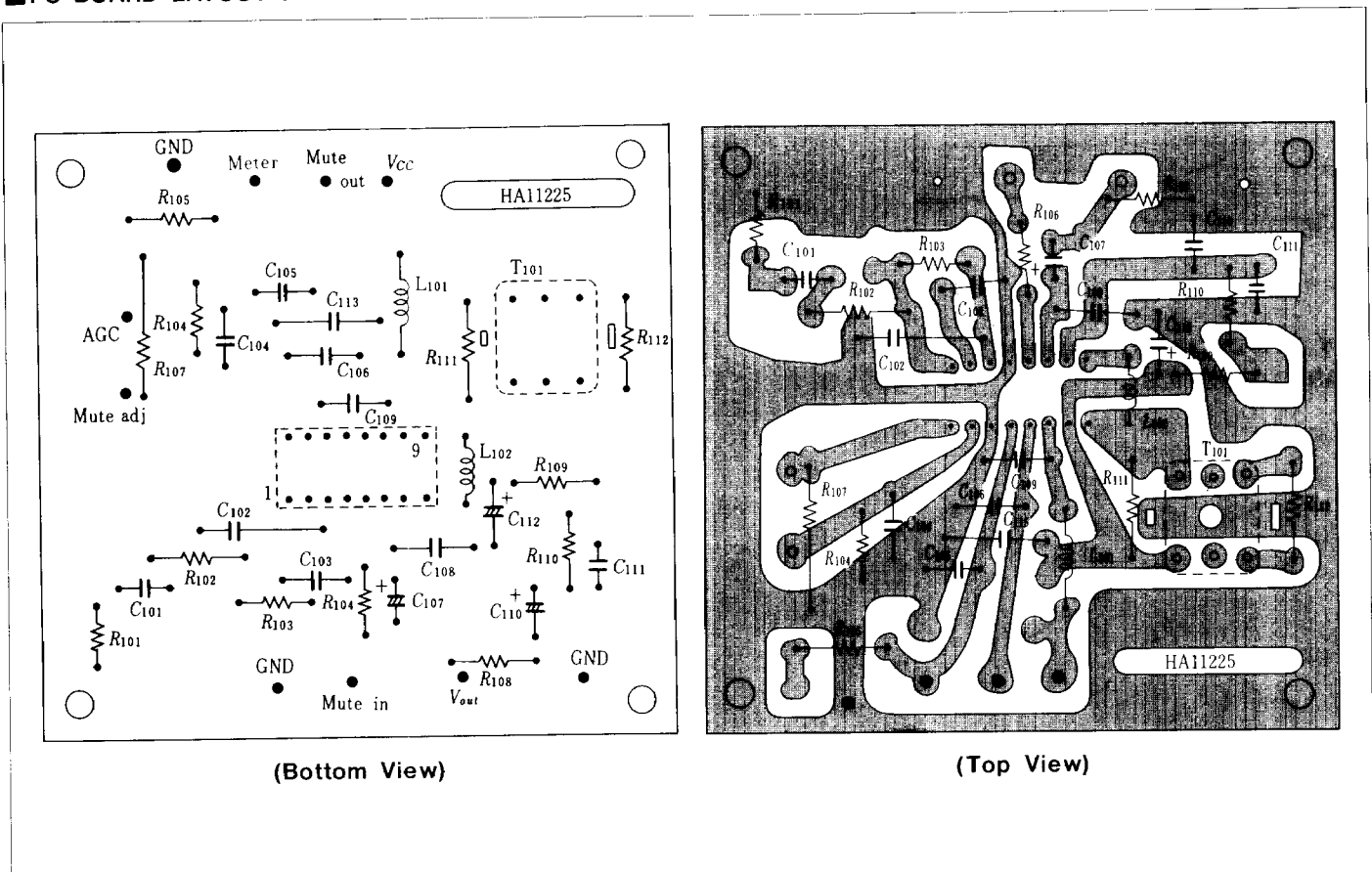

DETECTOR OUTPUT, SIGNAL-TO-NOISE RATIO AND AM REJECTION VS. INPUT VOLTAGE

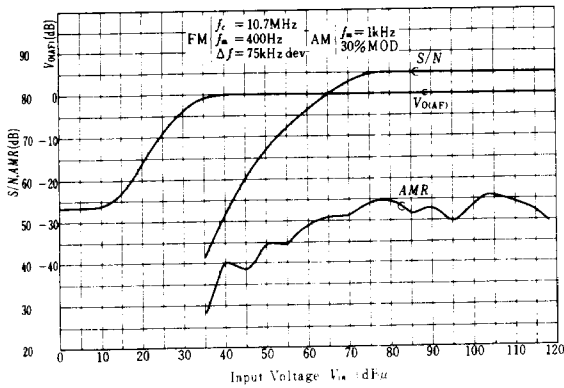

MUTE CONTROL VOLTAGE, AGC CONTROL VOLTAGE AND METER DRIVE VOLTAGE VS. INPUT VOLTAGE

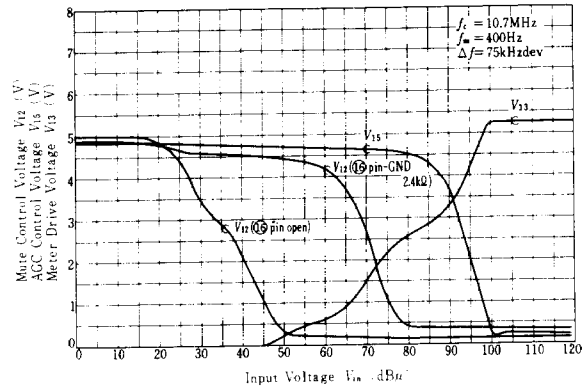

TOTAL HARMONIC DISTORTION VS. INPUT VOLTAGE

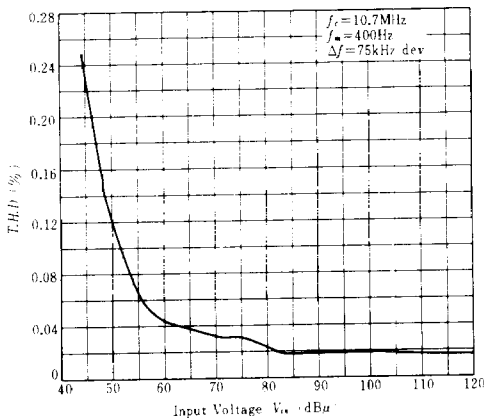

AFC VOLTAGE VS. INPUT VOLTAGE

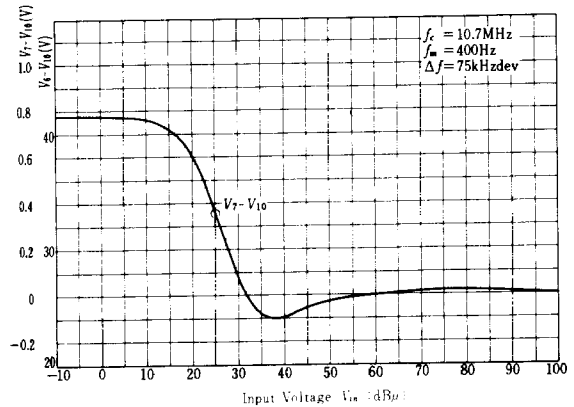

V7-V10, V12 DETUNING FREQUENCY CHARACTERISTICS

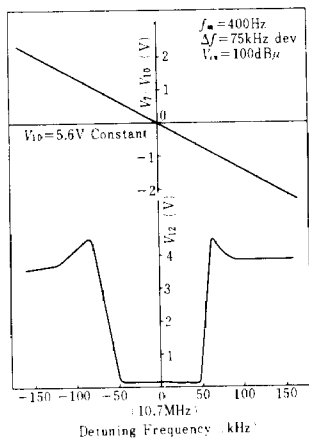

TOTAL HARMONIC DISTORTION VS. DETUNING FREQUENCY

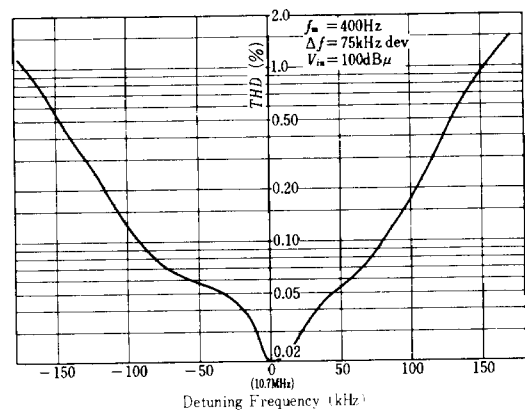

OUTPUT VOLTAGE AND TOTAL HARMONIC DISTORTION VS. MODULATION FREQUENCY

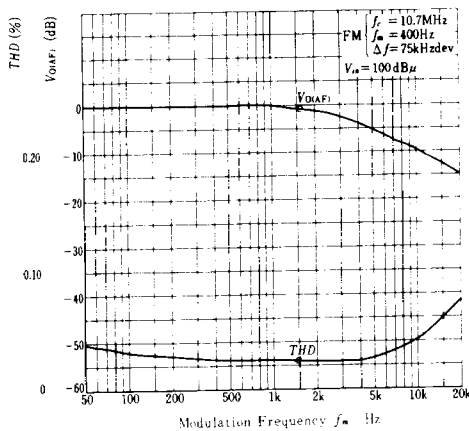

INPUT VOLTAGE VS. SUPPLY VOLTAGE

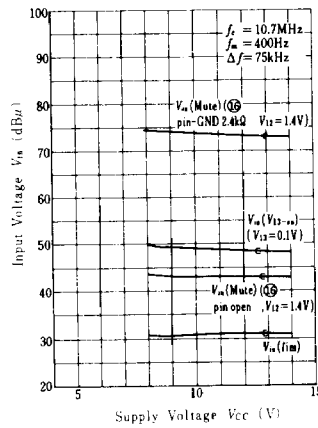

MUTE ATTENUATION, OUTPUT VOLTAGE, AM REJECTION RATIO AND SUPPLY CURRENT VS. SUPPLY VOLTAGE

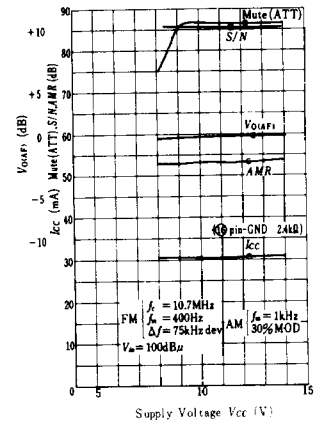

MUTING BANDWIDTH, V_7-V_{10} AND TOTAL HARMONIC DISTORTION VS. SUPPLY VOLTAGE

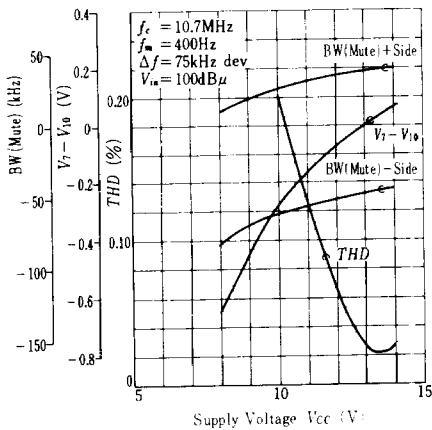

MUTE ATTENUATION, SIGNAL-TO-NOISE RATIO, AM REJECTION RATIO AND OUTPUT VOLTAGE VS. AMBIENT TEMPERATURE

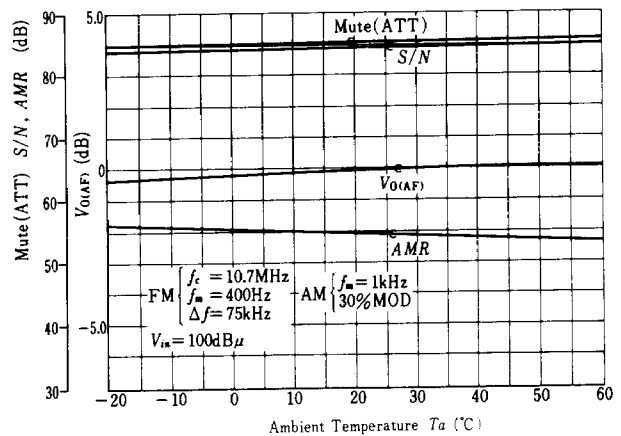

BANDWIDTH AND TOTAL HARMONIC DISTORTION VS. AMBIENT TEMPERATURE

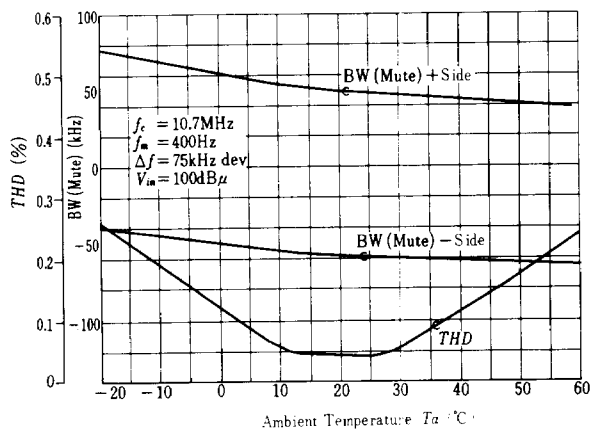

INPUT VOLTAGE VS. AMBIENT TEMPERATURE

