

JVC

SERVICE MANUAL

COMPUTER CONTROLLED FM/AM TUNER

MODEL T-X900B/T-X900LB



T-X900B



T-X900LB

Contents

	Page		Page
Safety Precautions	1 - 1	6-(3) FM dB Display	1 - 8
1. Specifications	1 - 2	6-(4) MPX Section	1 - 8
2. Names of Parts and Their Functions	1 - 3	6-(5) MW Section	1 - 9
3. Block Diagram	1 - 5	6-(6) LW Section	1 - 9
4. Disassembly		6-(7) AM dB Display	1 - 9
4-(1) Removal of Top Cover	1 - 6	7. T-X900B/T-X900LB Schematic Diagrams	
4-(2) Removal of Front Panel	1 - 6	7-(1) T-X900B Tuner Section	1-10
4-(3) Removal of Logic P.C. Board	1 - 6	7-(2) T-X900LB Tuner Section	1-11
4-(4) Removal of Bottom Board	1 - 6	7-(3) T-X900B Logic Section	1-12
5. Locations of Adjusting Parts	1 - 7	7-(4) T-X900LB Logic Section	1-13
6. Adjustment Procedures		7-(5) T-X900B/T-X900LB Power Supply Section	1-14
6-(1) Frontend	1 - 8	Parts List	Separate-volume Insertion
6-(2) IF and Detector	1 - 8		

Safety Precautions

1. The design of this product contains special hardware, many circuits and components specially for safety purposes.
For continued protection, no changes should be made to the original design unless authorized in writing by the manufacturer. Replacement parts must be identical to those used in the original circuits. Service should be performed by qualified personnel only.
2. Alterations of the design or circuitry of the product should not be made. Any design alterations or additions will void the manufacturer's warranty and will further relieve the manufacturer of responsibility for personal injury or property damage resulting therefrom.
3. Many electrical and mechanical parts in the product have special safety-related characteristics. These characteristics are often not evident from visual inspection nor can the protection afforded by them necessarily be obtained by using replacement components rated for higher voltage, wattage, etc. Replacement parts which have these special safety characteristics are identified in the parts list of Service manual. Electrical components having such features are identified by shading on the schematics and by (\triangle) on the parts list in Service manual. The use of a substitute replacement which does not have the same safety characteristics as the recommended replacement part shown in the parts list in Service manual may create shock, fire, or other hazards.
4. The leads in the products are routed and dressed with ties, clamps, tubings, barriers and/or the like to be separated from live parts, high temperature parts, moving parts and/or sharp edges for the prevention of electric shock and fire hazard.

When service is required, the original lead routing and dress should be observed, and they should be confirmed to be returned to normal, after re-assembling.

5. Leakage current check

(Safety for electrical shock hazard)

After re-assembling the product, always perform an isolation check on the exposed metal parts of the Products (antenna terminals, knobs, metal cabinet, screw heads, headphone jack, control shafts, etc.) to be sure the product is safe to operate without danger of electrical shock.

Do not use a line isolation transformer during this check.

- Plug the AC line cord directly into the AC outlet. Using a "Leakage Current Tester", measure the leakage current from each exposed metal part of the cabinet, particularly any exposed metal part having a return path to the chassis, to a known good earth ground. Any leakage current must not exceed 0.5 mA AC (r.m.s.).

● Alternate check method

Plug the AC line cord directly into the AC outlet. Use an AC voltmeter having 1,000 ohms per volt or more sensitivity in the following manner. Connect a 1500 Ω 10 W resistor paralleled by a 0.15 μ F AC-type capacitor between an exposed metal part and a known good earth ground.

Measure the AC voltage across the resistor with the AC voltmeter.

Move the resistor connection to each exposed metal part, particularly any exposed metal part having a return path to the chassis, and measure the AC voltage across the resistor. Now, reverse the plug in the AC outlet and repeat each measurement. Any voltage measured must not exceed 0.75 V AC (r.m.s.). This corresponds to 0.5 mA AC (r.m.s.).

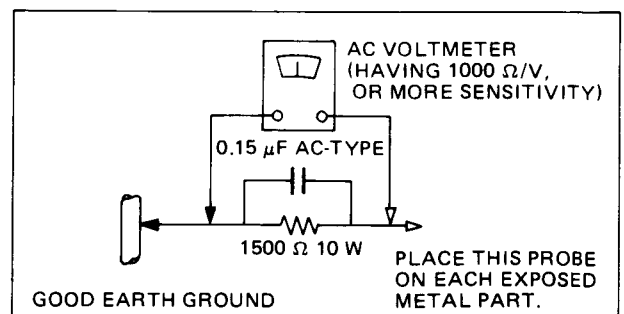

Fig. 1

CHECKING YOUR LINE VOLTAGE (Except for U.S.A., Canada, U.K. and Continental Europe)

Before inserting the power plug, please check this setting to see that it corresponds with the line voltage in your area. If it doesn't, be sure to adjust the voltage selector switch to the proper setting before operating this equipment. The voltage selector switch is located on the rear panel.

CAUTION: Before selecting the "Voltage selector switch" to proper voltage, disconnect the power plug.

1. Specifications

FM TUNER SECTION

Tuning range : 87.5—108MHz(T-X900B)
 87.9—107.9 MHz (T-X900B)
 87.5—108 MHz (T-X900LB)

Usable sensitivity : 0.90 μ V/75 Ω (10.3 dBf)

50 dB S/N sensitivity
 Monaural : 1.8 μ V/75 Ω (16.3 dBf)
 Stereo : 22 μ V/75 Ω (38.1 dBf)

46 dB quieting sensitivity
 Monaural : 2.5 μ V/75 Ω (DIN)
 Stereo : 23 μ V/75 Ω (DIN)

26 dB quieting sensitivity: 0.8 μ V/75 Ω (DIN)

Signal-to-Noise ratio
 Monaural : 88 dB (IHF-A), 78 dB (DIN)
 Stereo : 82 dB (IHF-A), 72 dB (DIN)

Total harmonic distortion
 Monaural : 0.04% (at 1 kHz)
 Stereo : 0.06% (at 1 kHz)

Capture ratio : 1.0 dB

Alternate channel selectivity
 Wide : 30 dB, \pm 400 kHz (IHF)
 25 dB, \pm 300 kHz (DIN)
 Narrow : 80 dB, \pm 400 kHz (IHF)
 70 dB, \pm 300 kHz (DIN)

Image rejection ratio: 80 dB (at 98 MHz)

IF rejection ratio : 100 dB (at 98 MHz)

AM suppression ratio: 65 dB

Stereo separation : 55 dB (at 1 kHz)

Frequency response : 30 Hz — 15 kHz $^{+0.3}_{-1.0}$ dB

Antenna input : 75 Ω unbalanced
 impedance (2 systems changeover type)

Output signal level : 600 mV/2.2 k Ω (IHF)
 310 mV/2.2 k Ω (DIN)

Recording level : Corresponds to approx. 50% modulation of FM (333 Hz)

MW TUNER SECTION

Tuning range : 522—1,611kHz (T-X900B)
 530—1,620 kHz (T-X900B)
 522—1,611 kHz (T-X900LB)

Usable sensitivity : 300 μ V (Bar antenna)

Total harmonic distortion : 0.5 %

Signal-to-Noise ratio : 50 dB

Selectivity : 50 dB (\pm 9 kHz)

Image rejection ratio: 50 dB

IF rejection ratio : 60 dB

Output signal level : 200 mV/2.2 k Ω (at 30% modulation)

LW TUNER SECTION

Tuning range : 144—353 kHz

Usable sensitivity : 400 μ V/m (Bar antenna)

Total harmonic distortion : 0.5 %

Signal-to-Noise ratio : 50 dB

Selectivity : 50 dB (\pm 9 kHz)

GENERAL

Power specifications : See Table below.

Dimensions : 77(H) x 435(W) x 298(D) mm
 (3-1/32" x 17-1/8" x 11-1/2")

Weight : 3.8 kg (8.37 lbs)

Accessories : Signal cord (1.2 m) x 1

Note: Specifications and design are subject to change for improvement without prior notice.

POWER SPECIFICATIONS

Areas	Line Voltage & Frequency	Power Consumption	
		Power ON	Standby
U.S.A. & Canada	AC 120 V, 60 Hz	12 watts	1.8 watts
Continental Europe	AC 220 V \sim , 50 Hz	12 watts	1.8 watts
U.K. & Australia	AC 240 V \sim , 50 Hz	12 watts	1.8 watts
Other areas	AC 110/120/220/240 V \sim , Selectable, 50/60 Hz	12 watts	1.8 watts

2. Names of Parts and their Functions

T-X900B

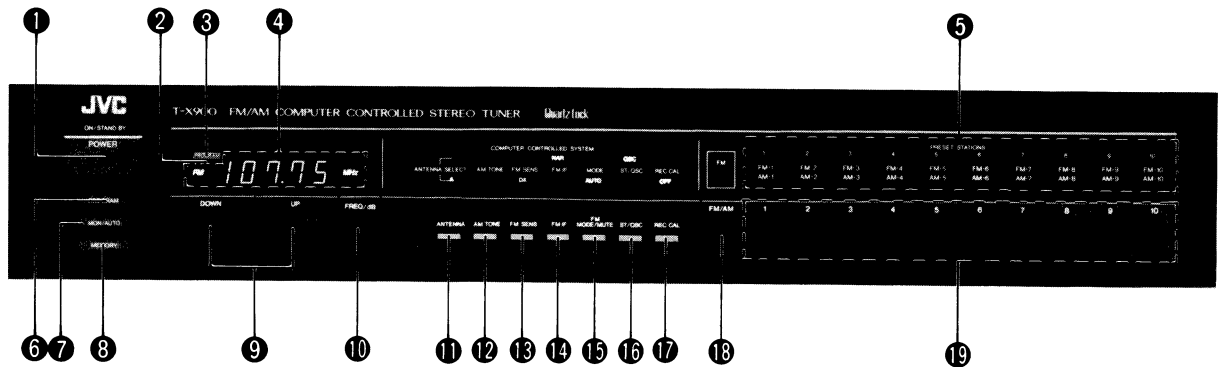

① POWER switch

Press this switch to turn the power on. The frequency indicator, etc. lights. To set to STAND BY, press this switch again.

Notes:

- The memory circuit of this unit remains in the stand-by mode even when the POWER switch the frequencies in memory. When the POWER switch is set to ON again, the previously received broadcast will be received. The preset frequencies will be retained in memory even if the power cord is disconnected, a power failure occurs or an audio timer is used for the time of power interruption not exceeding about 7 days at normal temperature.
- Even when the POWER switch is set to STANDBY, this tuner consumes a small amount of electricity (1.8 watts). To shut the power completely off, disconnect the power cord.

② MEMORY indicator

When the MON/AUTO or MEMORY switch is pressed, this indicator lights for about 5 seconds.

③ PROGRAM indicator

When the PROGRAM switch is pressed, this indicator lights to show that programming for unattended recording can be performed.

Note:

- When this indicator lights, only the MEMORY and MON/AUTO switches can not be operated.

④ Frequency/signal strength indication

This displays the frequency in MHz for FM and in kHz for AM (MW/LW) and the signal strength in dB.

⑤ Preset station indication

Up to 10 FM and 10 AM (MW/LW) stations can be preset; use the station name sheet to index them.

⑥ PROGRAM switch

Up to 7 broadcasts can be programmed. When programming, press this switch and the MEMORY switch so that the PROGRAM and MEMORY indicators light.

⑦ MON/AUTO switch

In case of program monitor

When several broadcasts have been programmed, press the PROGRAM switch and this MON/AUTO switch to check the frequencies in order that they have been programmed.

In case of auto memory

Press this switch so that the MEMORY indicator lights, and press the desired PRESET STATIONS button while the MEMORY indicator is lit; the received frequency changes in the upward direction and if there are broadcasts, their frequencies will be stored in memory in order. In this case, the AM TONE is stored in memory as AUTO.

The FM SENS, FM IF and ST/QSC are automatically set to correspond to the optimum reception conditions and stored in memory. FM ANT A/B is not stored in memory.

Note:

Auto memory is impossible if the PRESET STATIONS button is pressed after the MEMORY indicator has gone out.

T-X900LB

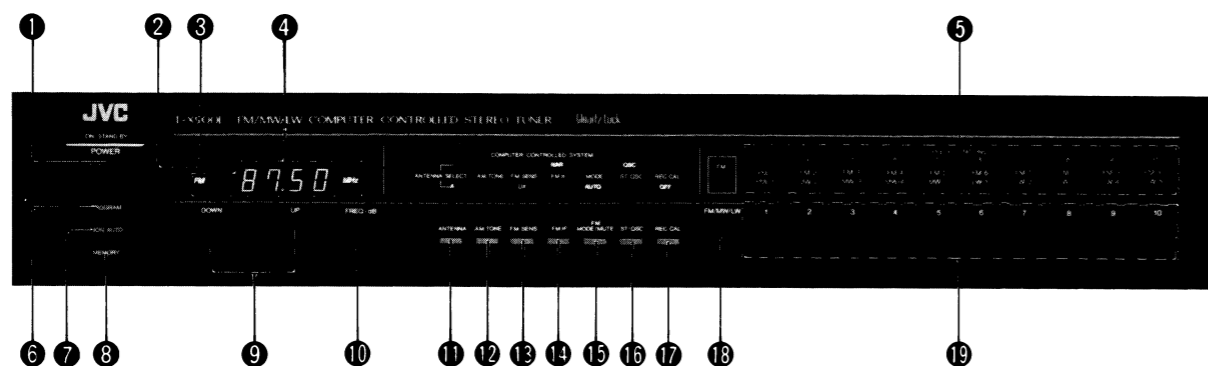
**8 MEMORY switch**

When this switch is pressed, the MEMEMORY indicator will light for about 5 seconds to show that the memory is ready to receive preset station information. Press one of the PRESET STATIONS button while the MEMORY indicator is lit. When the FM ANT A/B switch is pressed to set it to A or B while the MEMORY indicator is lit, the antenna selected is also stored in memory.

Notes:

- After the MEMORY indicator has gone out, pressing the PRESET STATIONS buttons will not store the frequency in memory; in this case, press the MEMORY switch again.
- Be sure to store the antenna selected in memory at the same time when presetting broadcasts because the antenna selected cannot be separately stored in memory.

9 TUNING buttons

DOWN (◀): Press to tune to lower frequencies.

UP (▶): Press to tune to higher frequencies.

Channel spacing

AM channel spacing switch (T-X900B only) is provided on the rear panel for selecting 9 kHz or 10 kHz steps according to your area.

Band Area	FM	AM (MW)	AM (LW)
U.S.A., Canada	100 kHz	*10 kHz/ 9 kHz	—
Continental Europe, U.K., Australia	50 kHz	9 kHz	1 kHz
Other areas	*50 kHz	*9 kHz	—
	100 kHz	10 kHz	

Notes:

*Preset at the factory.

Press the POWER switch to set to STANDBY each time the AM channel spacing switch is changed.

10 FREQ/dB switch

Pressing this switch displays the signal strength in dB; 0 dB corresponds to 1 μ V/75 ohms in FM and 1 μ V/m in AM. To display the frequency, press this switch again. The optimum signal strength is more than 40 dB for FM mono, more than 60 dB for FM stereo and 70 dB for AM.

Note:

- When this switch is pressed, the displayed signal strength may change slightly from time to time because the signal strength is measured continuously and is subject to fluctuation. If the signal is too weak or too strong, this display may not indicate the correct value.
- The dB indication is very useful in finding the best antenna direction when a rotary external FM antenna is used. For more details, refer to "TIPS FOR BETTER FM RECEPTION" on page 15.
- Depending on whether the FM IF indicator shows WIDE or NAR, the dB display of the FM signal strength may be different. Setting to WIDE displays the more correct dB value. When receiving an LW broadcast, dB indication is not shown even if the FREQ/dB switch is pressed (T-X900LB only).

11 FN/ANT A/B switch

Use to select the antenna connected to the ANTENNA- or ANTENNA-B terminals on the rear panel. The A or B of the ANT A/B indicator lights.

12 AM TONE switch

Normally set so that the AM TONE indicator shows NORM; set so that the AM TONE indicator shows HIFI for reception of Hi-Fi signals in a strong signal strength area.

13 FM SENS switch

Normally set so that the FM SENS indicator shows DX; in areas where the input signal is too strong and there is interference, press this switch so that the "–10" (about 10 dB attenuation) or "–10" and "–15" (about 25 dB attenuation) is indicated according to the signal strength. When the dB indication is set while listening to an FM broadcast, "DX", "–10" or "–15" may flicker depending on the signal strength.

Note:

The T-X900B/T-X900LB measures the antenna input, therefore, even if this switch is pressed for 10 or 25 dB attenuation, the signal strength indication may not change.

14 FM IF switch

Normally set so that the FM IF indicator shows WIDE; set so that the FM IF indicator shows NAR (narrow) when there is interference in a strong or weak signal strength area.

15 FB MODE/MUTE switch

Normally set so that the MODE indicator shows AUTO; set so that the MODE indicator shows MONO when the reception condition of the signal is bad. When AUTO is displayed, FM stereo broadcasts are received in stereo and FM monaural broadcasts in mono. When MONO is displayed, even if the broadcast is FM stereo, it will be received in mono but noise is reduced so that it sounds better.

16 ST/QSC switch

When a signal strength of an FM stereo broadcast is low, the QSC indicator on this switch lights and the QSC (Quieting Slope Control) circuit is switched on to reduce noise.

When the signal strength is sufficiently high, this circuit will be released automatically. It is possible to release the QSC circuit by pressing this switch. The ST indicator on this switch lights when an FM stereo broadcast is being received. If the FM broadcast is stereo when the MODE indicator shows MONO, this indicator will not light; press the FM MODE/MUTE switch so that AUTO is shown.

17 REC CAL switch

Press this to check the recording level of an AM or an FM broadcast; the REC CAL indicator shows ON. When this indicates ON, the standard signal of 333 Hz will be output; adjust the REC LEVEL control on the tape deck so that the recording level meter indicates 0 VU. It is best to set the recording level for different broadcasts or types of tape; for more details, refer to the tape deck's instruction manual.

Note:

When the standard signal of 333 Hz is output, it is impossible to listen to broadcast; after checking the recording level, be sure to press this again so that the OFF is indicated.

18 FM/AM switch (T-X900B); FM/MW/LW switch (T-X900LB)

When listening to an FM broadcast:

Press this switch so that FM is displayed.

When listening to an AM broadcast:

Press this switch so that AM is displayed.

Note (for T-X900LB only):

- As an MW and LW reception is shown as AM, to confirm MW or LW reception, check its frequency reading.

19 PRESET STATIONS button (1–10)

As each of the PRESET STATIONS buttons can store one FM and one AM (MW/LW) frequency, 10 AM (MW/LW) and 10 FM stations can be preset. Press one of the PRESET STATIONS buttons while the MEMORY indicator is lit to preset it. Once a frequency has been preset, just press the corresponding button to call it up. When one of the PRESET STATIONS buttons is pressed, its channel number changes from orange to red.

Note:

- When receiving FM broadcasts, FM SENS, FM IF and QSC are set to the best positions automatically to correspond to the reception condition and their conditions are stored in memory. Therefore, when the power is switched on again, the same condition is called up but, if the tuner is moved or the direction of the antenna is changed, be sure to preset again.

3. Block Diagram

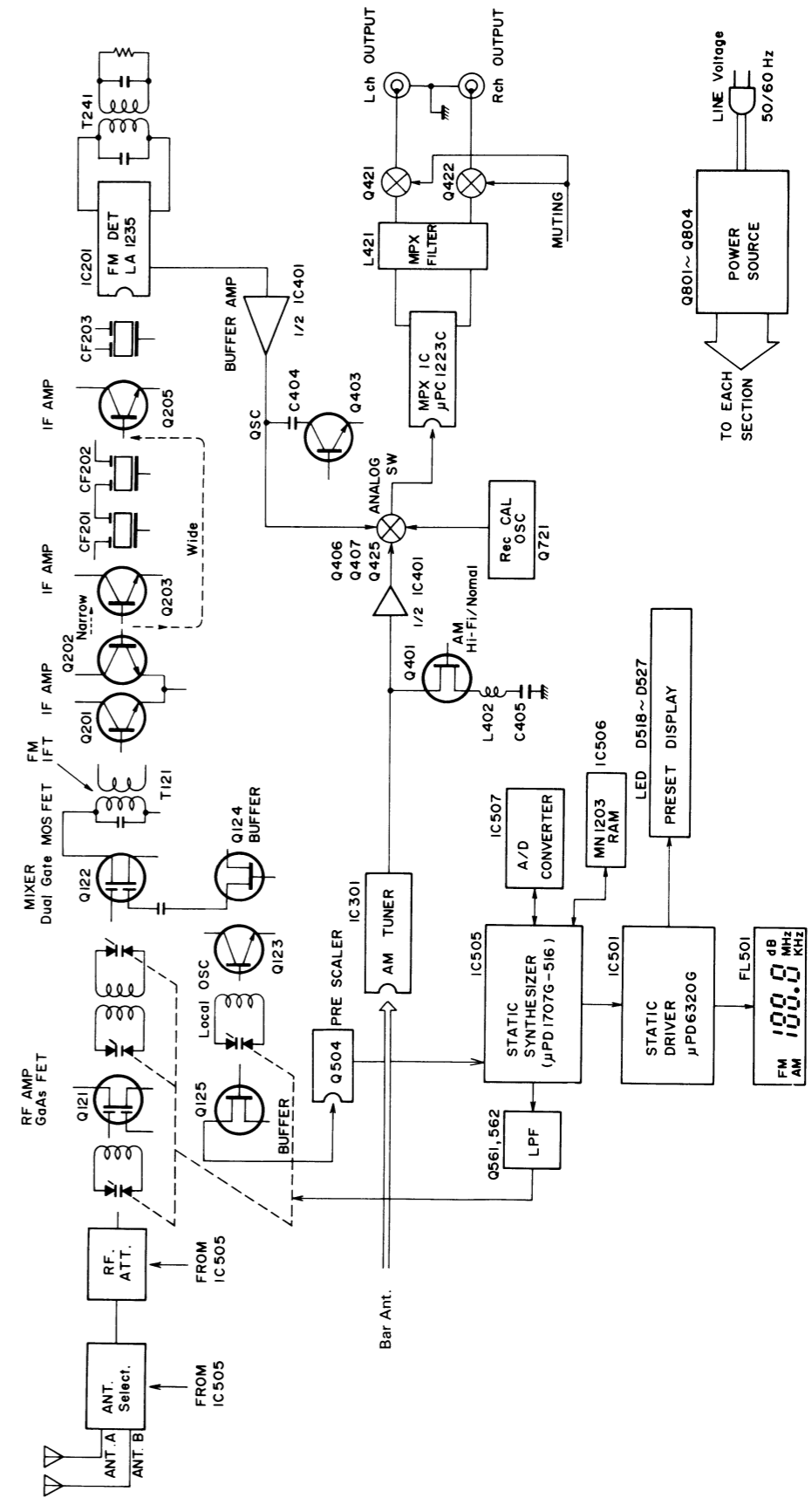

4. Disassembly

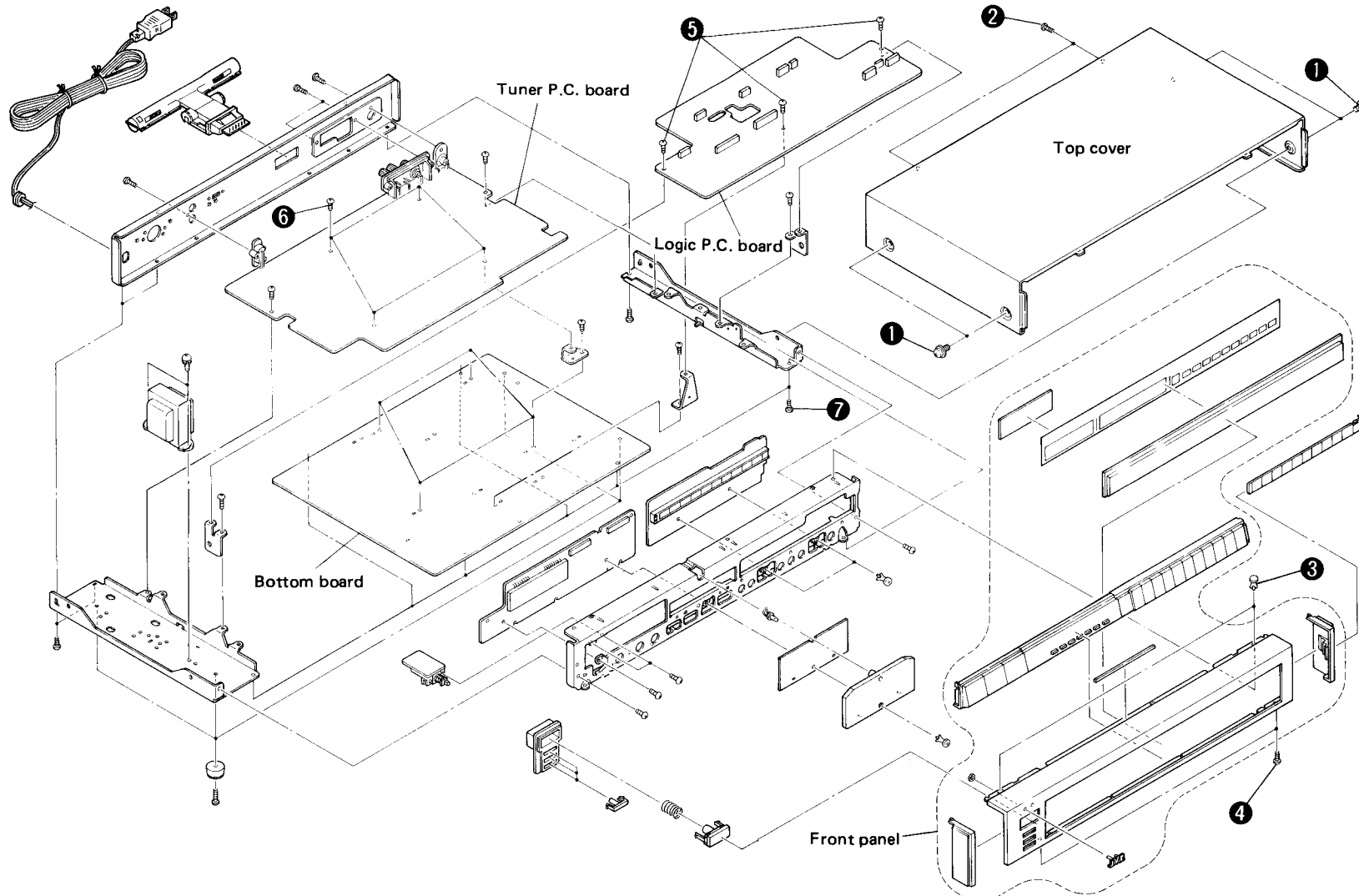

4-(1) Removal of Top Cover

1. Loosen four screws ① from both sides.
2. Loosen two screws ② from rear panel.

4-(2) Removal of Front Panel

1. Remove the top cover (see above).
2. Extract two plastic rivets ③ from panel top.
3. Loosen two screws ④ from panel bottom.

4-(3) Removal of Logic P.C. Board

1. Remove the top cover (see above).
2. Loosen three screws ⑤ holding the P.C. board.
3. Disengage three connectors (7-pin, 4-pin, 7-pin) located at right this side.
4. Disengage two flat wires (white card like ones) located at middle this side.
5. Thus, the logic P.C. board can be turned upside down.

4-(4) Removal of Bottom Board

1. Remove the top cover and then the logic P.C. board (see above).
2. Loosen four screws ⑥ holding the tuner P.C. board.
3. Loosen four screws ⑦ securing the bottom board.
4. Thus patterns of the tuner P.C. board can be checked.

5. Locations of Adjusting Parts

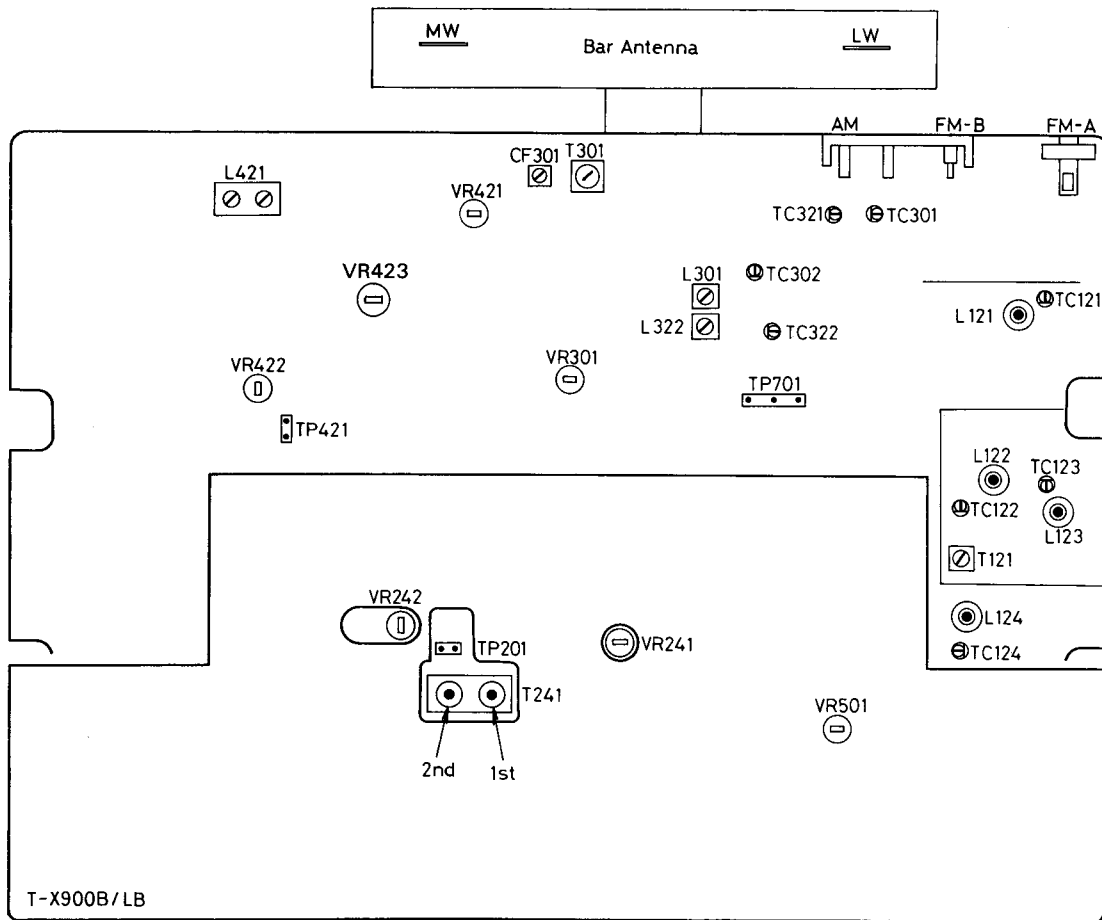

6. Adjustment Procedures

To adjust the cores, use an adjusting rod made of bakelite, polycarbonate or other nonmetallic materials.

[FM Section]

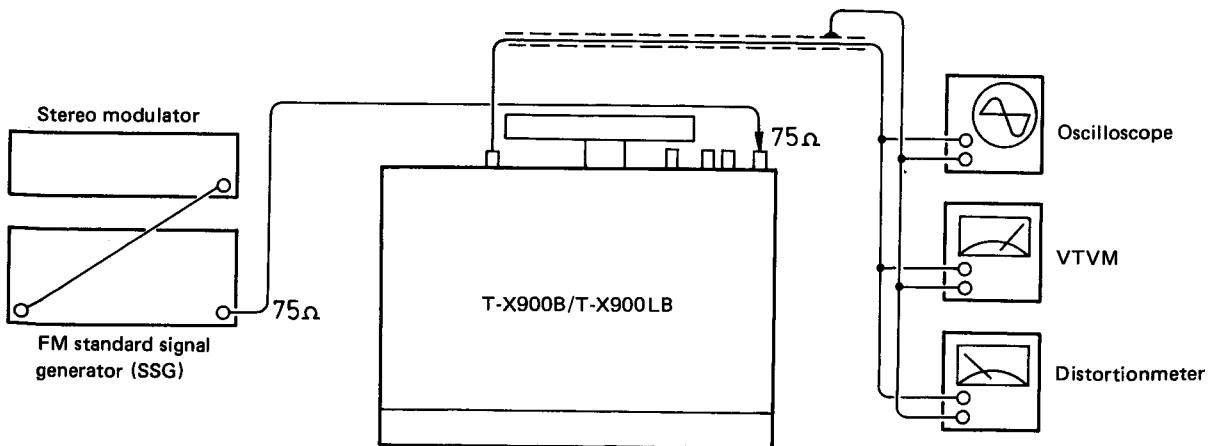

6-(1) Frontend

L124 : FM oscillator tuning coil

Set the frequency display to 87.9 MHz, select MONO by the FM MODE/MUTE switch, and make sure noise is developed when there is no input. Then adjust the voltage to 7.5 ± 0.1 V at TP701 (SERVO VOLTAGE).

TC124 : FM oscillator tuning trimmer

Set the frequency display to 107.9 MHz, select MONO by the FM MODE/MUTE switch, and make sure noise is developed when there is no input. Then adjust the voltage to 22.0 ± 0.1 V at TP701 (SERVO VOLTAGE).

L121 : FM ANT tuning coil

L122 : FM RF1 tuning coil } Adjust so the sensitivity
L123 : FM RF2 tuning coil } is optimum at 88.9 MHz.

TC121 : FM ANT tuning trimmer

TC122 : FM RF1 tuning trimmer } Adjust so the sensitivity
TC123 : FM RF2 tuning trimmer } is optimum at 105.9 MHz.

Note: After adjustment, confirm that the band cover is as follows: (for West Germany only)

FM: Low-end 87.5 MHz – 300 kHz
High-end 108.0 MHz + 500 kHz

6-(2) IF and Detector

T241 : FM detection coil

Receive a station, connect a center meter or digital voltmeter to test point TP201, and make adjustment by turning the primary of T241 so the center meter reads "0" or the digital voltmeter reads 0 mV. Adjust the secondary so the distortion is a minimum.

VR241: Muting level adjusting rheostat

Set the FM MODE/MUTE switch to AUTO/ON. Make adjustment so that the sound is not heard when SG input is 15 dB and is heard when 16 dB to 20 dB.

Turning this rheostat clockwise increases the muting level and vice versa.

6-(3) FM dB Display (when SSG is available)

1. Rotate VR501 fully clockwise.
2. Set SSG ATT to 54 dB, receive the signal, and slowly turn VR242 clockwise from the counterclockwise position until the dB display on FL is 54 dB.
3. Set SSG ATT to 10 dB. If the dB display on FL is 10 dB or higher, the adjustment has been completed.
4. If the dB display on FL is 0 dB when SSG ATT is set to 10 dB, slowly rotate VR501 counterclockwise until the dB display is 10 dB.
5. Set SSG ATT again to 54 dB, and adjust VR242 until the display on FL is 54 dB.

During the adjusting steps 1 through 5, keep knob "FREQ/dB" depressed and make sure LED "-10" does not flash.

When SSG is unavailable

- Using an FM/TV field intensity meter, check the field intensity, and then carry out the above adjustment.

6-(4) MPX Section

VR422: MPX VCO free-run frequency adjusting rheostat

Connect a frequency counter to test point TP421, and adjust the free-run frequency to 76 kHz. Turning the rheostat clockwise lowers the free-run frequency and vice versa.

VR421: Channel separation adjusting rheostat

VR423: Adjust VR421 so the crosstalk from the R channel to the L channel is a minimum, and adjust VR423 so the crosstalk from the L channel to the R channel is a minimum. Turning this rheostat clockwise reduces the cancelling amount and vice versa.

Note: L421 (MPX LPF) which is factory adjusted need not be readjusted.

When replacing FM ceramic filter

- When replacing ceramic filters CF201, CF202 and CF203 of the FM section, be sure to use the same colored ceramic filters. After the replacement, adjust T121 and T241 to minimize the distortion and adjust VR421 to maximize the separation.

6-(5) MW Section

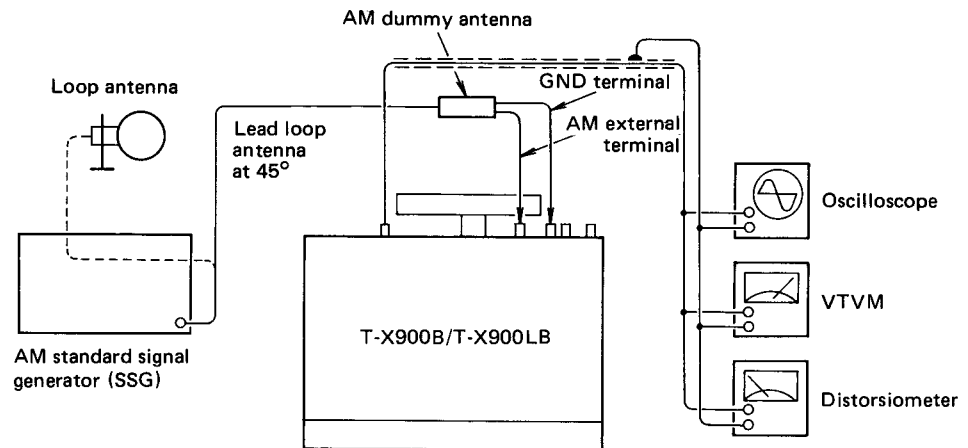
**L301 : MW oscillator tuning coil**

Display the frequency of 522 kHz (or 530 kHz) and adjust the voltage at TP701 (SERVO VOLTAGE) to 2.0 ± 0.1 V.

TC302 : MW oscillator tuning trimmer

Display the frequency of 1605 kHz (or 1611 kHz, 1620 kHz) and adjust the voltage at TP701 (SERVO VOLTAGE) to 22.0 ± 0.1 V.

- : **MW bar antenna coil**

Adjust the sensitivity to an optimum at 603 kHz.

TC301 : MW antenna tuning trimmer

Adjust the sensitivity to an optimum at 1404 kHz.

T301 : AM IFT**CF301 : AM IF filter**

} Factory adjusted, need not be readjusted.

6-(7) AM dB Display

1. Set SSG ATT to 60 dB and receive 999 kHz (use AM dummy antenna).
2. Holding down knob "FREQ/dB", adjust VR301 so the display on FL indicates 78 dB.

6-(6) LW Section (T-X900LB only)

L322 : LW oscillator tuning coil

Display the frequency of 144 kHz and adjust the voltage at TP701 (SERVO VOLTAGE) to 2.0 ± 0.1 V.

TC322 : LW oscillator tuning trimmer

Display the frequency of 353 kHz and adjust the voltage at TP701 (SERVO VOLTAGE) to 19.0 ± 0.1 V.

- : **LW bar antenna coil**

Adjust the sensitivity to an optimum at 164 kHz.

TC321 : LW antenna tuning trimmer

Adjust the sensitivity to an optimum at 353 kHz.

JVC

7. T-X900B/T-X900LB Schematic Diagram

7-(1) T-X900B Tuner Section

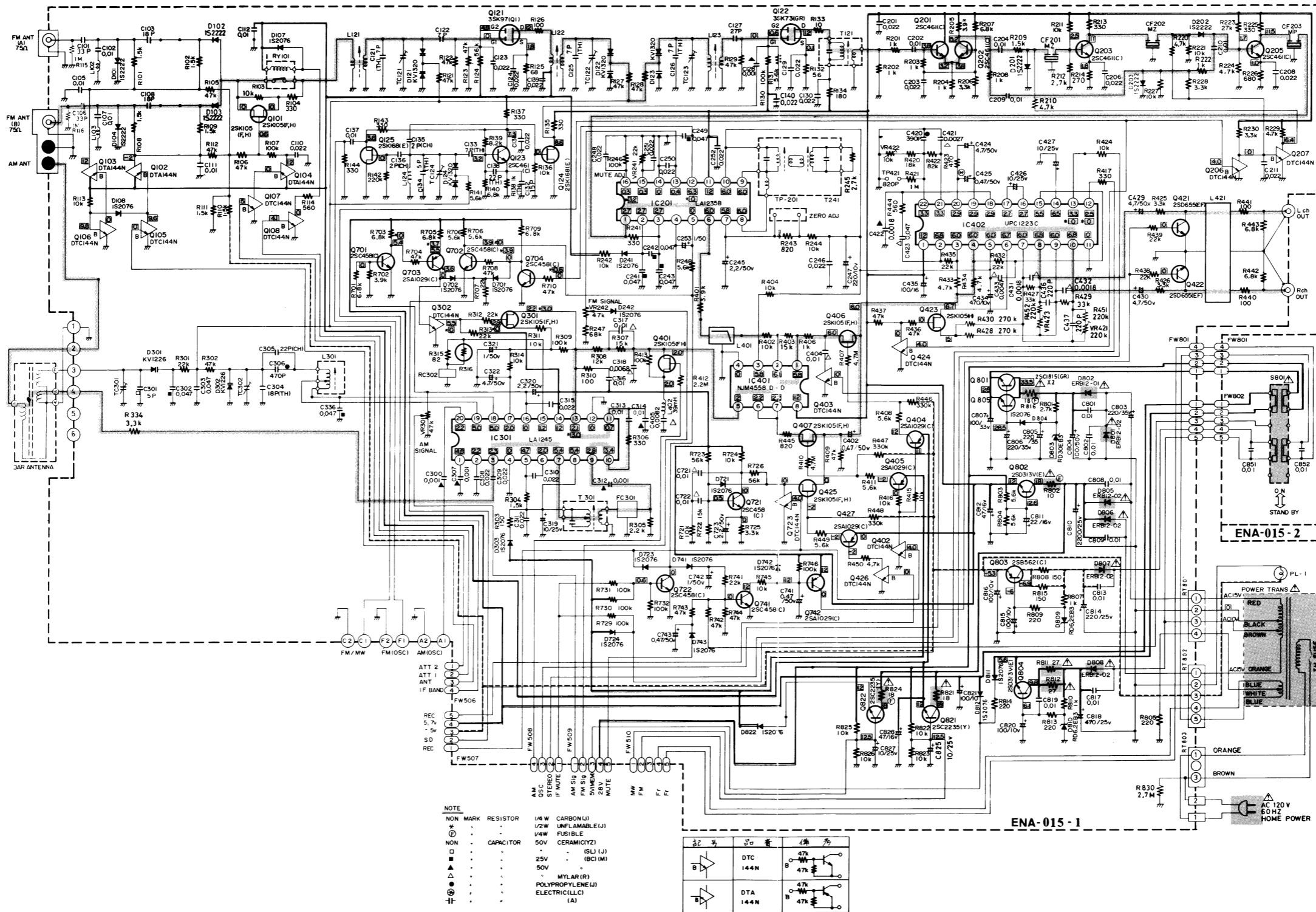

Notes:

- shows DC voltage to the chassis with no signal input.
- indicates positive B power supply.
- - - indicates negative B power supply.
- [Pattern] indicates signal path.
- When replacing the parts in the darkened area (■) and those marked with △, be sure to use the designated parts to ensure safety.
- This is the standard circuit diagram. The design and contents are subject to change without notice.

7-(2) T-X900B Logic & Display Section

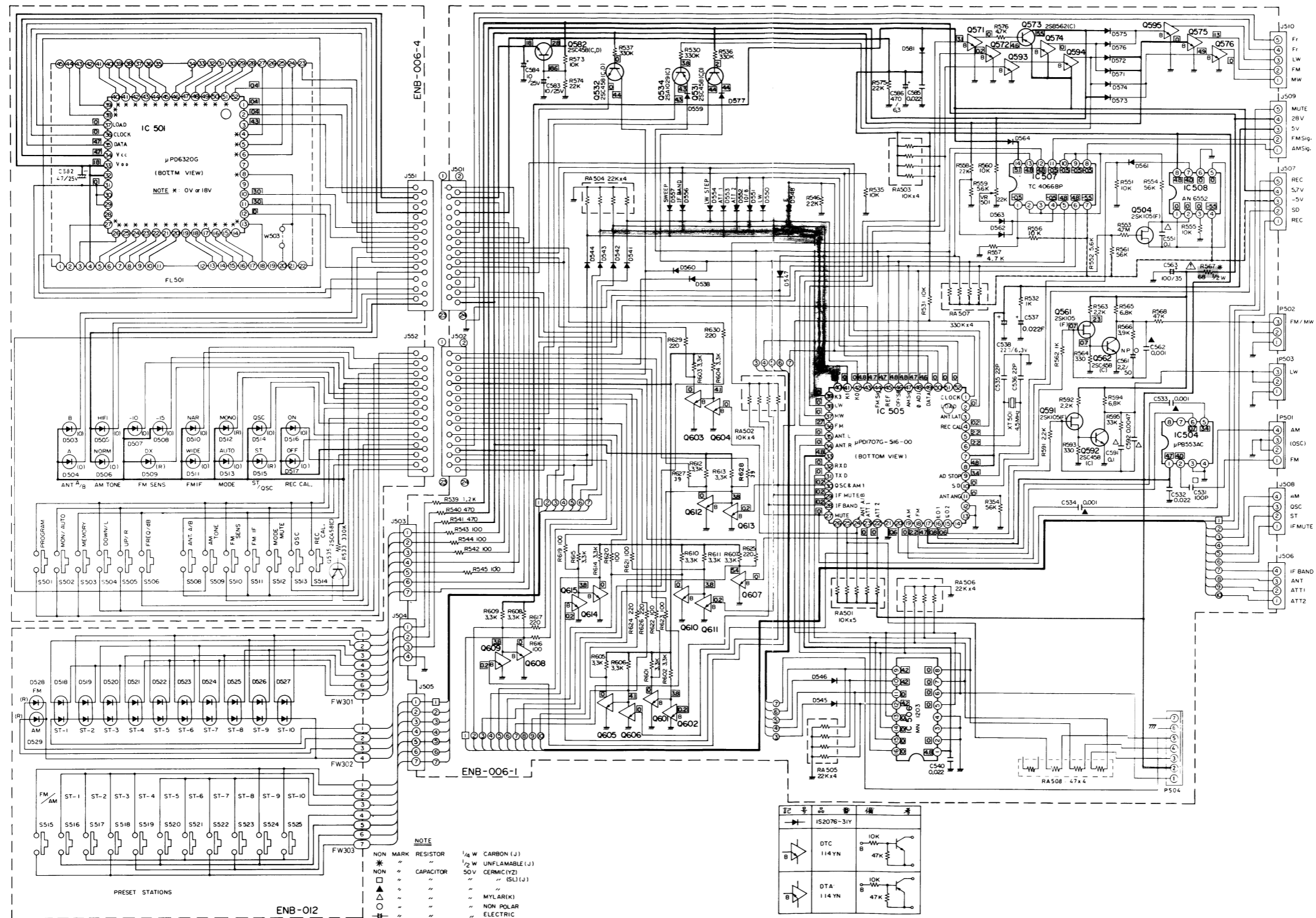

Notes:

1. shows DC voltage to the chassis with no signal input.
2. indicates positive B power supply.
3. indicates negative B power supply.
4. When replacing the parts in the darkened area () and those marked with , be sure to use the designated parts to ensure safety.
5. This is the standard circuit diagram. The design and contents are subject to change without notice.

7-(3) T-X900LB Tuner Section

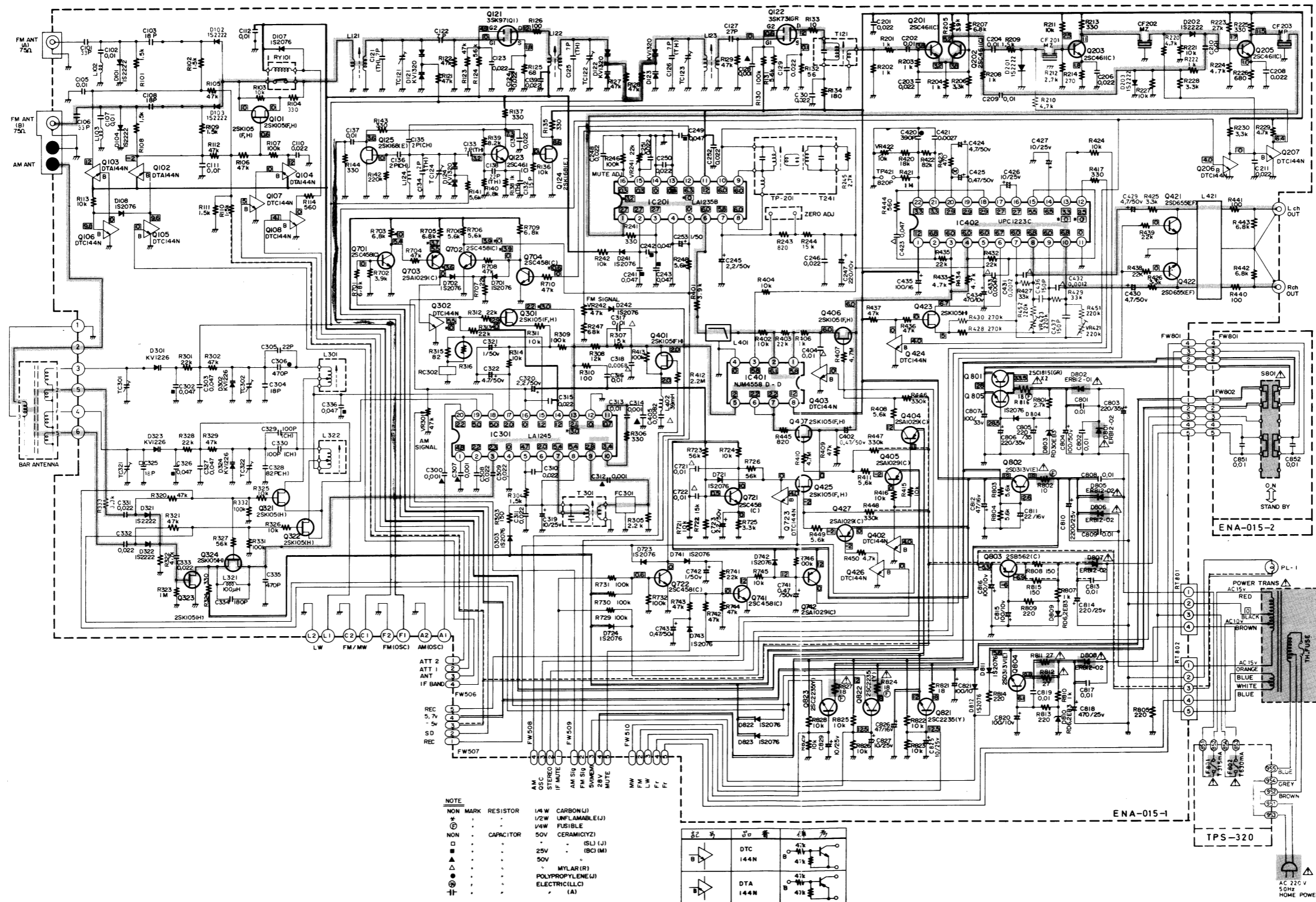

Notes:

1. shows DC voltage to the chassis with no signal input.
2. indicates positive B power supply.
3. indicates negative B power supply.
4. indicates signal path.
5. When replacing the parts in the darkened area () and those marked with , be sure to use the designated parts to ensure safety.
6. This is the standard circuit diagram. The design and contents are subject to change without notice.

7-(4) T-X900LB Logic & Display Section

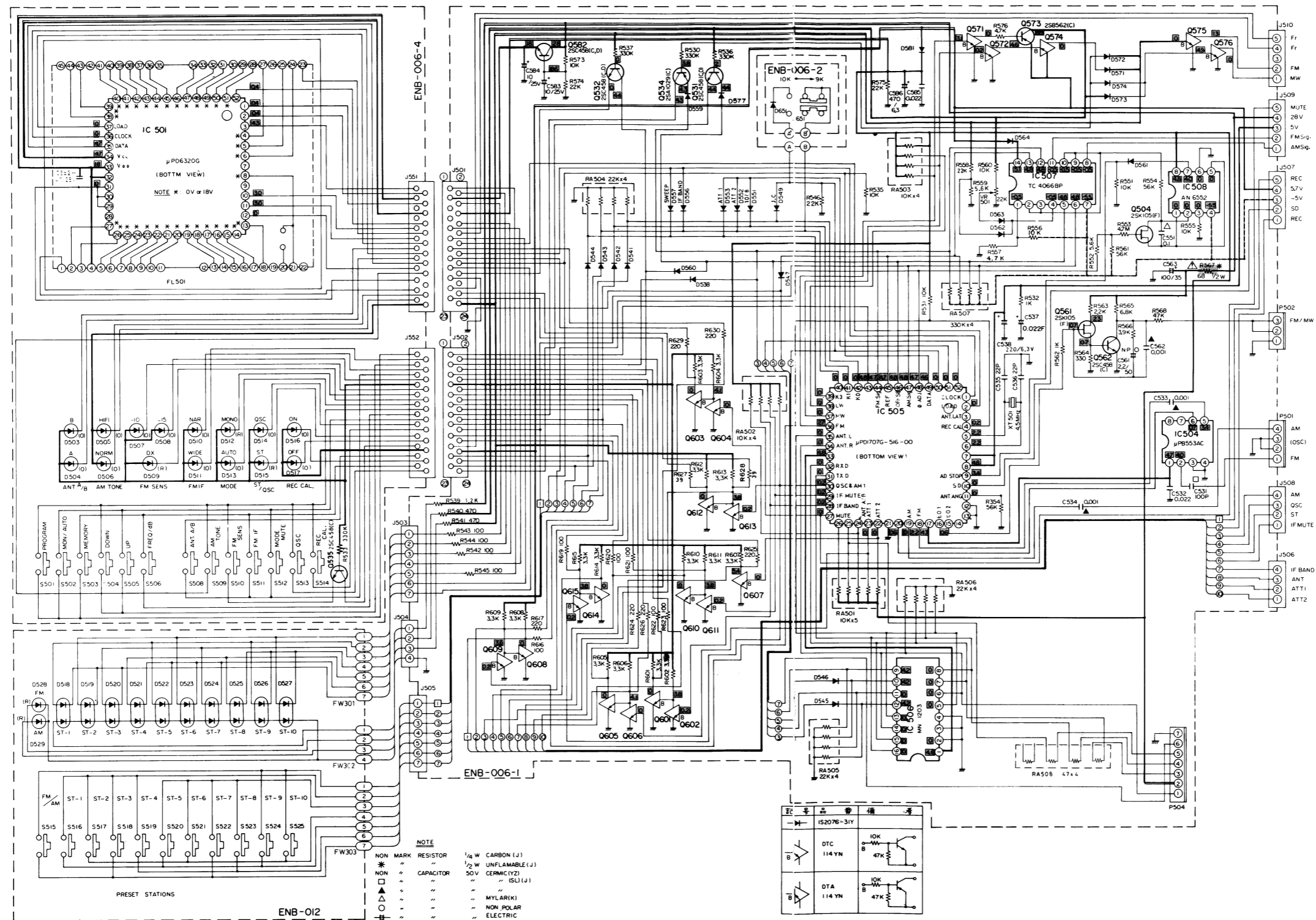

Notes:

1. shows DC voltage to the chassis with no signal input.
2. indicates positive B power supply.
3. indicates negative B power supply.
4. When replacing the parts in the darkened area () and those marked with , be sure to use the designated parts to ensure safety.
5. This is the standard circuit diagram. The design and contents are subject to change without notice.

7-(5) T-X900B/T-X900LB Power Supply Section

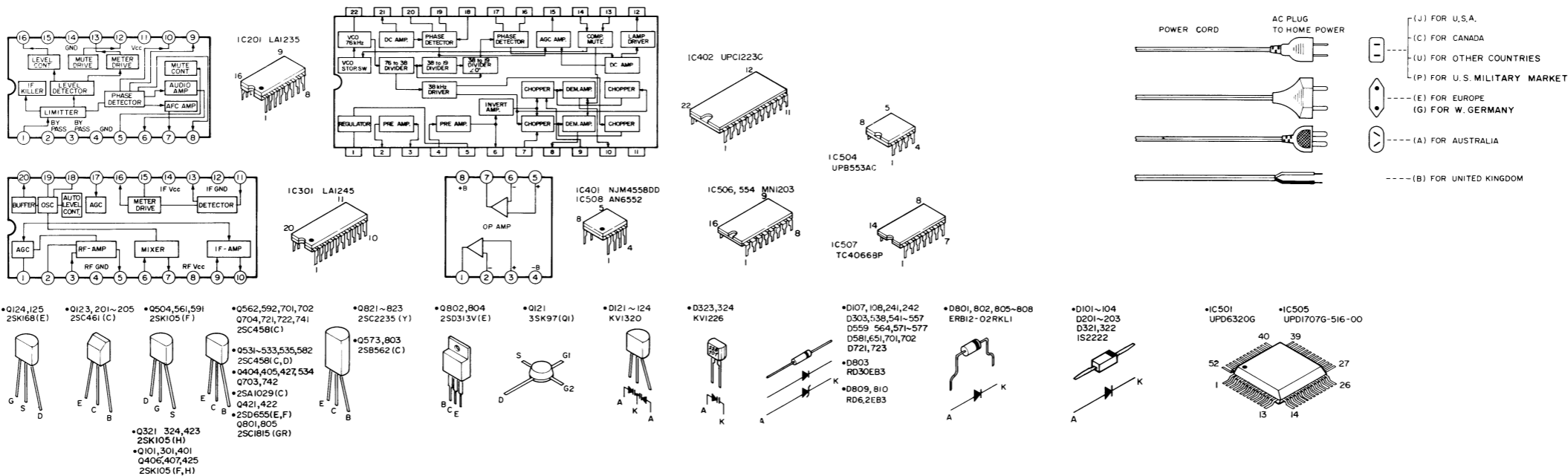
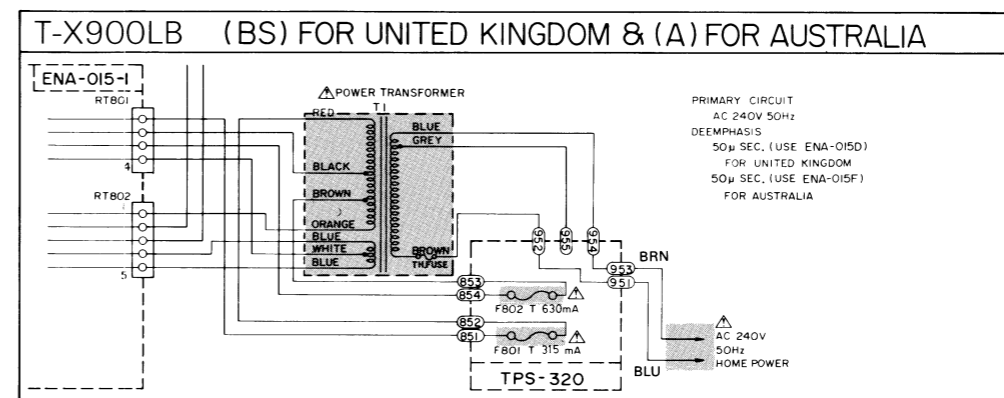
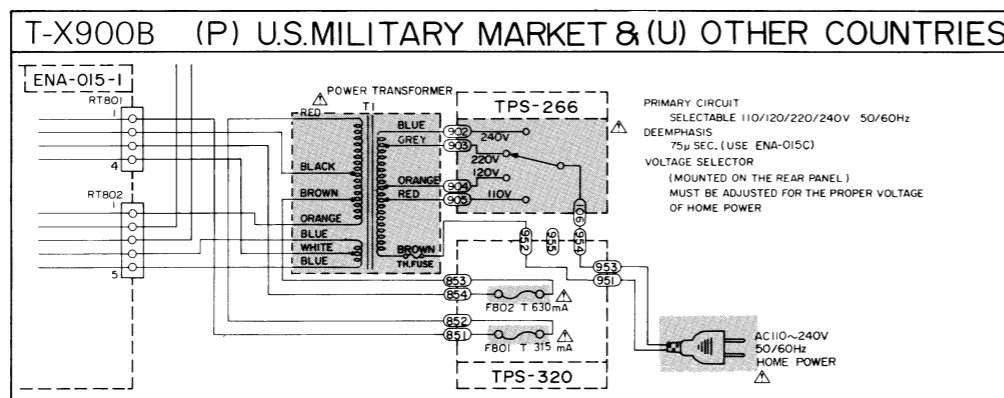
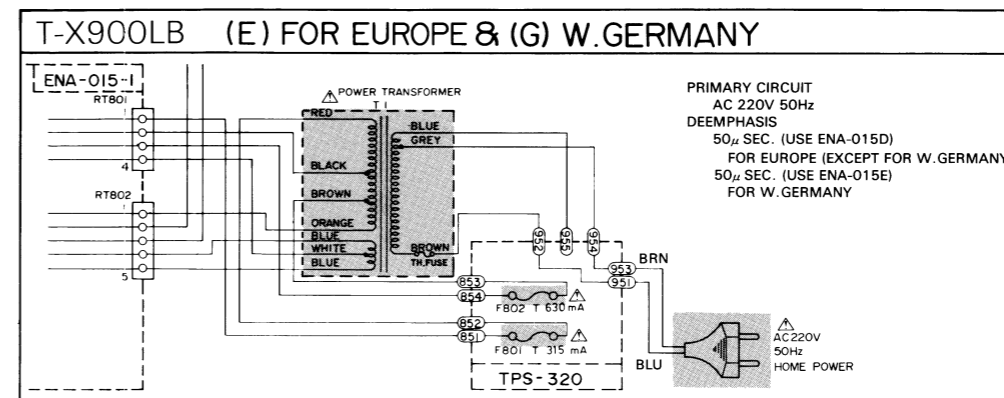
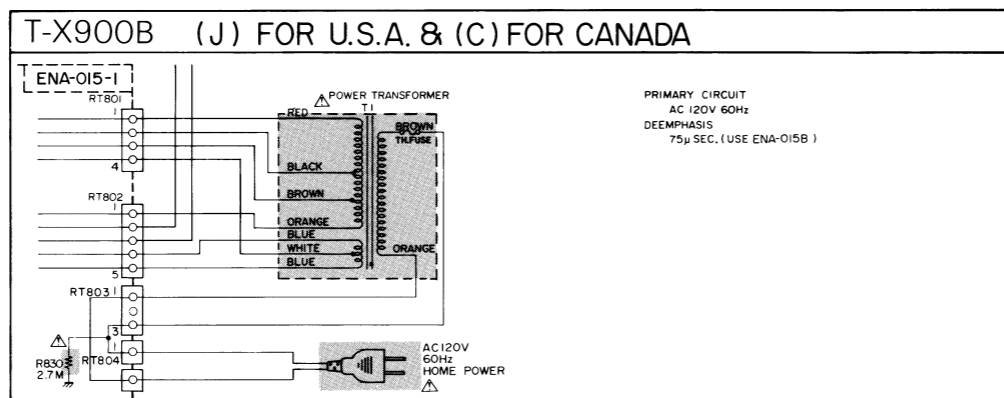

Notes:

1. When replacing the parts in the darkened area (■) and those marked with △, be sure to use the designated parts to ensure safety.
2. This is the standard circuit diagram.
The design and contents are subject to change without notice.

PARTS LIST

Contents

1. Main Parts Locations	2- 2
1-(1) Top View	2- 2
1-(2) Front View	2- 2
1-(3) Rear View	2- 2
2. Exploded View and Part Numbers	2- 3
3. Printed Circuit Board Ass'y and Parts List	2- 5
3-(1) ENA 015 □ Tuner P.C.Board Ass'y	2- 5
3-(2) ENB-006 □ Logic(2) P.C.Board Ass'y	2-11
3-(3) ENB-012 □ Logic(1) P.C. Board Ass'y	2-15
3-(4) TPS-320KBS Fuse P.C.Board Ass'y	2-16
3-(5) TPS-320J Fuse P.C.Board Ass'y	2-16
3-(6) TPS-266C Voltage Selector P.C.Board Ass'y	2-16
4. Packing Materials and Part Numbers	2-17
5. Accessories List	2-17

1. Main Parts Locations

1-(1) Top View

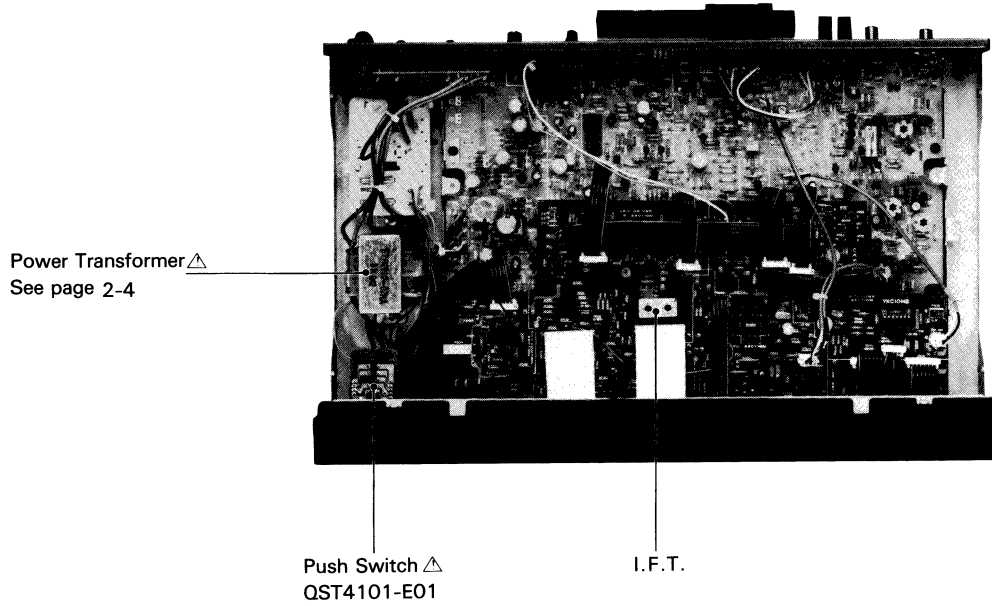

1-(2) Front View

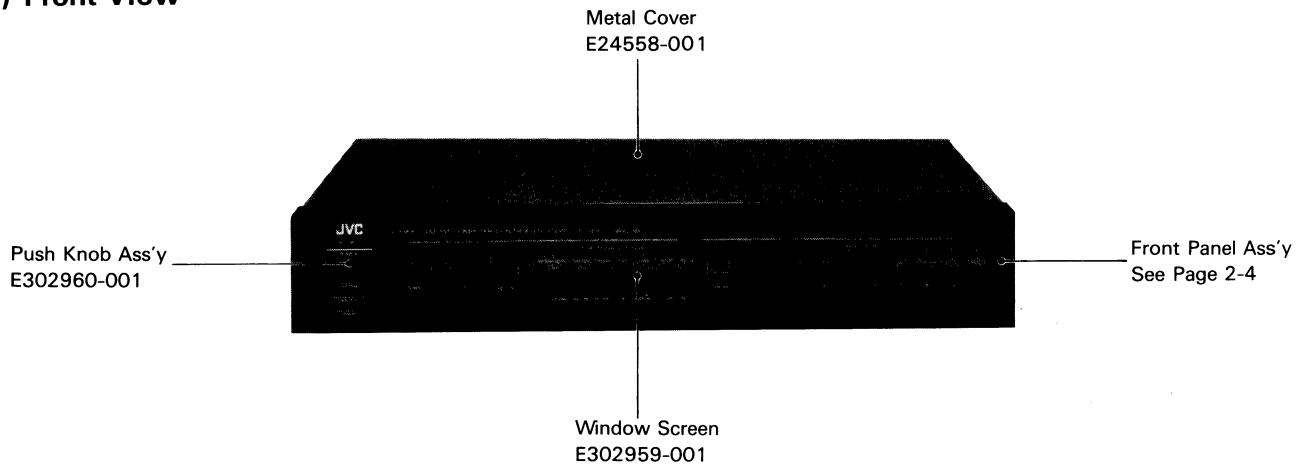

1-(3) Rear View

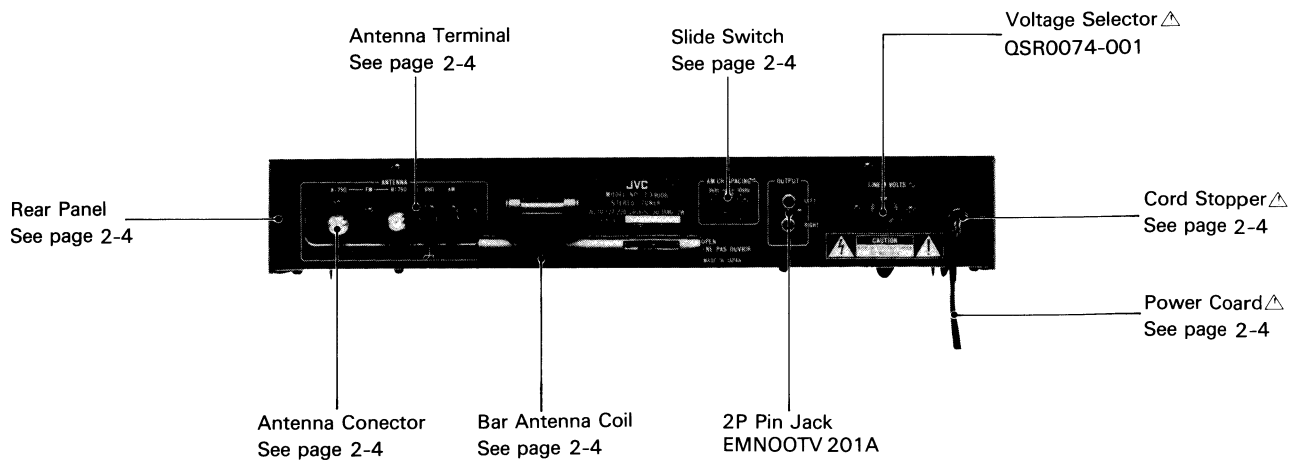

Δ Safety Parts

2. Exploded View and Part Numbers

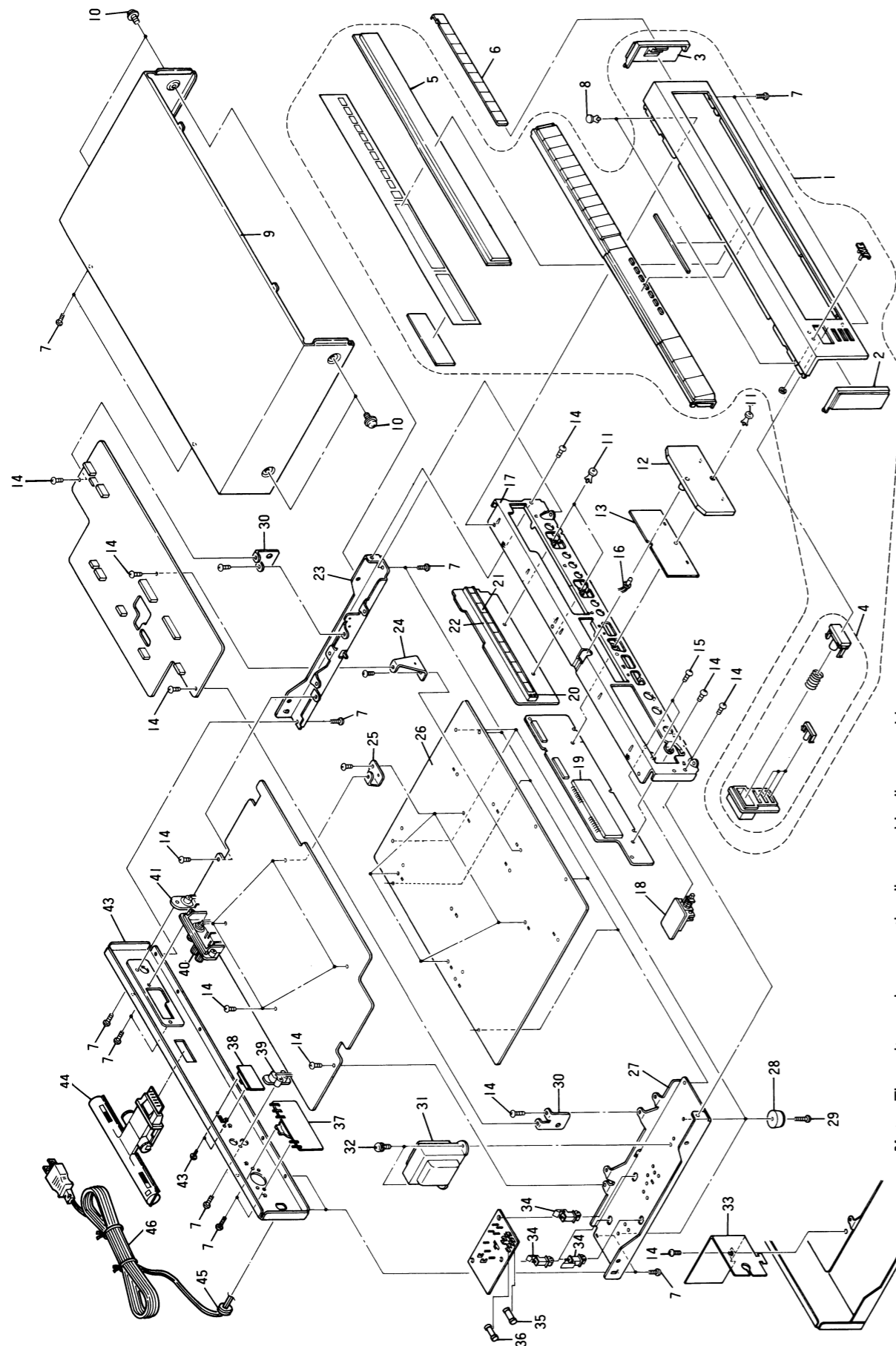

Note: Those items shown on the disassembly diagram without indication of reference Nos. are supplied as assembly parts.

No.	Part Number	Part Name	Q'ty	Description	Area
1	EFP-TX900E	Front Panel Ass'y	1		
2	EFP-TX900LE	Front Panel Ass'y	1		
3	E302966-001	Side Fitting	1	Left	
4	E302966-002	Side fitting	1	Right	
5	E302960-001	Push Knob Ass'y	1		
6	E302959-001	Window Screen	1		
7	E302971-001	Channel Holder Ass'y	1		J.C.P.PG.A.U
8	E302971-002	Channel Holder Ass'y	1		LE.LES.LBS.LG
9	SBSB3008M	Tapping Screw	1		
10	E48729-009	Plastic Rivet	2		
11	E24558-001	Metal Cover	1		
12	E61660-004	Special Screw	4		
13	E48729-008	Plastic Rivet	3		
14	E302967-005	Scale	1		
15	E302969-004	Back Screen	1		
16	SBSB3008N	Tapping Screw	1		
17	E65119-001	Special Screw	1		
18	ELP3105-6065C	Lamp	1		
19	E10916-001	Front Blacket	1		
20	QST4101-E01	Push Switch	1	△ Power	
21	ELU0001-021	F.L. Tube	1		
22	LD-101VW	L.E.D	2		
23	LD6301	L.E.D	10		
24	E302973-001	L.E.D. Holder	1		
25	E301749-002	Side Blacket	1		
26	E70889-001	Blacket	1		
27	E68587-001	Blacket	4		
28	E23913-004	Bottom Cover	1		
29	E301748-009	Side Blacket	1		J.C.
30	E301748-008	Side Blacket	1		P.PG.A.LE.LES.LBS.LG.U
31	E47227-012	Foot	4		
32	SBSB3010M	Tapping Screw	4		
33	E70888-001	Blacket	2		
34	ETP1010-07JA	Power Transformer	1	△	J.C.
35	ETP1010-07HA	Power transformer	1	△	P.PG.U
36	ETP1010-24EA	Power transformer	1	△	LE.LES.LG.A
37	ETP1010-24EABS	Power transformer	1	△	LBS
38	E65389-002	Ass'y Screw	2		
39	E69245-001	Protector	1		LBS
40	E34455-001	Fastener	3		P.PG.A.LE.LES.LBS.LG
41	QMF51A2-R315L	Fuse	1		P.PG.A.LE.LES.LG.U
42	QMF51A2-R315LBS	Fuse	1		LBS
43	QMF51A2-R63L	Fuse	1		P.PG.A.LE.LES.LG.U
44	QMF51A2-R63LBS	Fuse	1		LBS
45	QSR0074-001	Voltage Selector	1		P.PG.U
46	QSS2201-002	Slide Switch	1	△	J.C.P.PG.A.U
47	EMN00TV201A	2P Pin Jack	1		
48	E03752-019F	Antenna Terminal	1		J.C.P.PG.A.U
49	E03752-019P	Antenna Terminal	1		LE.LES.LBS
50	EMB01YV-201A	Antenna Terminal	1		LG
51	EMB91YV-101A	Antenna Conector	1		J.C.P.PG.A.U
52	EMB91YV-102A	Antenna Conector	1		LE.LES.LBS.LG
53	E24556-002	Rear Panel	1		J.C.P.PG.U
54	E24556-003	Rear Panel	1		A.LE.LBS.LG
55	E24556-004	Rear Panel	1		LES
56	SPST2604M	Screw	1	Slide Switch	J.C.P.PG.A.U
57	EQB3101-001	Bar Antenna Coil	1		J.C.P.PG.A.U
58	EQB3204-004	Bar Antenna Coil	1		LE.LES.LBS.LG
59	QHS3876-162	Cord Stopper	1	△ Power Cord	J.C.P.PG.A.LE.LES.LG.U
60	QHS3876-162BS	Cord Stopper	1	△ Power Cord	LBS
61	QMP1200-200	Power Cord	1	△	J.C
62	QMP2560-244	Power Cord	1	△	A
63	QMP3900-200	Power Cord	1	△	LE.LES.LG
64	QMP7600-250	Power Cord	1	△	P.PG.U
65	QMP9017-008BS	Power Cord	1	△	LBS

△ Safety Parts

The Marks by Designated Area	
J	U.S.A
C	Canada
P,PG	U.S.Military Market
LE	Europe
LES	Spain
LG	West Germany
A	Australia
LBS	U.K.
U	Other Countries

Diodes

ITEM	PART NUMBER	DESCRIPTION	
D321	1S2222	SILICON	NEC
D321	1S2222	SILICON	NEC
D322	1S2222	SILICON	NEC
D322	1S2222	SILICON	NEC
D323	KV1226	SILICON	TOKO
D323	KV1226	SILICON	TOKO
D324	KV1226	SILICON	TOKO
D701	1S2076-31	SILICON	HITACHI
D702	1S2076-31	SILICON	HITACHI
D721	1S2076-31	SILICON	HITACHI
D722	1S2076-31	SILICON	HITACHI
D723	1S2076-31	SILICON	HITACHI
D724	1S2076-31	SILICON	HITACHI
D741	1S2076-31	SILICON	HITACHI
D742	1S2076-31	SILICON	HITACHI
D743	1S2076-31	SILICON	HITACHI
D801	ERB12-02RKL1	SILICON	FUJIDENKI
D802	ERB12-02RKL1	SILICON	FUJIDENKI
D803	RD30EB3	SILICON	NEC
D804	1S2076-31	SILICON	HITACHI
D805	ERB12-02RKL1	SILICON	FUJIDENKI
D806	ERB12-02RKL1	SILICON	FUJIDENKI
D807	ERB12-02RKL1	SILICON	FUJIDENKI
D808	ERB12-02RKL1	SILICON	FUJIDENKI
D809	RD6.2EB3	SILICON	NEC
D810	RD6.2EB3	SILICON	NEC
D811	1S2076-31	SILICON	HITACHI
D812	1S2076-31	SILICON	HITACHI
D821	1S2076-31	SILICON	HITACHI
D822	1S2076-31	SILICON	HITACHI
D823	1S2076-31	SILICON	HITACHI
D823	1S2076-31	SILICON	HITACHI
D824	1S2076-31	SILICON	HITACHI
D825	RD12EB3	SILICON	NEC

D
E
E

D
E

Coils

ITEM	PART NUMBER	DESCRIPTION	
L101	EQR4104-001	BALUN	
L102	EQL0005-R09	INDUCTOR	
L103	EQL0005-R09	INDUCTOR	
L121	EQR2106-005	RF COIL	
L122	EQR2106-010	RF COIL	
L123	EQR2106-010	RF COIL	
L124	EQR2406-002	RF COIL	
L301	EQR1207-003	RF COIL	
L321	EQL3001-101KY	INDUCTOR	
L321	EQL3001-101KY	INDUCTOR	
L322	EQR1307-002	RF COIL	
L322	EQR1307-002	RF COIL	
L402	EQL2103-393	INDUCTOR	
T121	EQT2121-002	I.F.T.	
T241	EQT2140-003	I.F.T.	
T301	EQT1021-005	I.F.T.	

D
E
E

Capacitors

ITEM	PART NUMBER	DESCRIPTION		
C101	QCS31HJ-330	33PF	50V	CERAMIC
C102	QCF31HP-103	0.01MF	50V	CERAMIC
C103	QCS31HJ-180	18PF	50V	CERAMIC
C104	QCF31HP-103	0.01MF	50V	CERAMIC
C105	QCF31HP-103	0.01MF	50V	CERAMIC
C106	QCS31HJ-330	33PF	50V	CERAMIC
C107	QCF31HP-103	0.01MF	50V	CERAMIC
C108	QCS31HJ-180	18PF	50V	CERAMIC
C109	QCF31HP-103	0.01MF	50V	CERAMIC
C110	QCF31HP-223	0.022MF	50V	CERAMIC

ITEM	PART NUMBER	DESCRIPTION		
C111	QCF31HP-103	0.01MF	50V	CERAMIC
C112	QCF31HP-103	0.01MF	50V	CERAMIC
C122	QCS31HJ-7R0	7PF	50V	CERAMIC
C121	QCT25TH-7R0Z	7PF	50V	CERAMIC
C123	QCF31HP-223	0.022MF	50V	CERAMIC
C124	QCF31HP-223	0.022MF	50V	CERAMIC
C125	QCT25TH-7R0	7PF	50V	CERAMIC
C126	QCT25TH-7R0	7PF	50V	CERAMIC
C127	QCS31HJ-270	27PF	50V	CERAMIC
C128	QCY31HK-102	1000PF	50V	CERAMIC
C129	QCF31HP-223	0.022MF	50V	CERAMIC
C130	QCF31HP-223	0.022MF	50V	CERAMIC
C131	QCF31HP-223	0.022MF	50V	CERAMIC
C132	QCT25TH-150	15PF	50V	CERAMIC
C133	QCT25TH-7R0	7PF	50V	CERAMIC
C134	QCT25TH-5R0	5PF	50V	CERAMIC
C135	QCT25CH-2R0	2PF	50V	CERAMIC
C136	QCT25CH-2R0	2PF	50V	CERAMIC
C137	QCF31HP-103	0.01MF	50V	CERAMIC
C138	QCT25TH-220	22PF	50V	CERAMIC
C139	QCF31HP-223	0.022MF	50V	CERAMIC
C140	QCF21HP-223	0.022MF	50V	CERAMIC
C201	QCF31HP-223	0.022MF	50V	CERAMIC
C202	QCF31HP-103	0.01MF	50V	CERAMIC
C203	QCF31HP-223	0.022MF	50V	CERAMIC
C204	QCF31HP-103	0.01MF	50V	CERAMIC
C205	QCF31HP-223	0.022MF	50V	CERAMIC
C206	QCF31HP-223	0.022MF	50V	CERAMIC
C207	QCF31HP-223	0.022MF	50V	CERAMIC
C208	QCF31HP-223	0.022MF	50V	CERAMIC
C209	QCF31HP-103	0.01MF	50V	CERAMIC
C210	QCF31HP-103	0.01MF	50V	CERAMIC
C211	QCF31HP-223	0.022MF	50V	CERAMIC
C241	QCC31EM-473	0.047MF	25V	CERAMIC
C242	QCC31EM-473	0.047MF	25V	CERAMIC
C243	QCC31EM-473	0.047MF	25V	CERAMIC
C244	QCS31HJ-221	220PF	50V	CERAMIC
C245	QET61HM-225	2.2MF	50V	ELECTRO
C246	QCF31HP-223	0.022MF	50V	CERAMIC
C247	QET61AM-227	220MF	10V	ELECTRO
C248	QCF31HP-223	0.022MF	50V	CERAMIC
C249	QCC31EM-473	0.047MF	25V	CERAMIC
C250	QCF31HP-223	0.022MF	50V	CERAMIC
C251	QCF31HP-223	0.022MF	50V	CERAMIC
C252	QCF31HP-223	0.022MF	50V	CERAMIC
C253	QET61HM-105	1MF	50V	ELECTRO
C300	QCY31HK-102	1000PF	50V	CERAMIC
C301	QCS31HJ-5R0	5PF	50V	CERAMIC
C301	QCS31HJ-5R0	5PF	50V	CERAMIC
C301	QCS31HJ-5R0	5PF	50V	CERAMIC
C302	QCC31EM-473	0.047MF	25V	CERAMIC
C303	QCF31HP-473	0.047MF	50V	ELECTRO
C304	QCS31HJ-180	18PF	50V	CERAMIC
C305	QCS31HJ-220	22PF	50V	CERAMIC
C306	QFP31HJ-431	430PF	50V	POLY
C307	QCY31HK-102	1000PF	50V	CERAMIC
C308	QCF31HP-223	0.022MF	50V	CERAMIC
C309	QCF31HP-223	0.022MF	50V	CERAMIC
C310	QCF31HP-223	0.022MF	50V	CERAMIC
C311	QCF31HP-223	0.022MF	50V	CERAMIC
C312	QCY31HK-102	1000PF	50V	CERAMIC
C313	QCF31HP-103	0.01MF	50V	CERAMIC
C314	QCF31HP-103	0.01MF	50V	CERAMIC
C314	QCF31HP-103	0.01MF	50V	CERAMIC
C314	QCF31HP-103	0.01MF	50V	CERAMIC
C314	QCY31HK-822	8200PF	50V	CERAMIC
C314	QCY31HK-822	8200PF	50V	CERAMIC
C315	QCF31HP-223	0.022MF	50V	CERAMIC
C316	QCF31HP-103	0.01MF	50V	CERAMIC
C317	QFN31HK-103	0.01MF	50V	MYLER
C318	QFN31HK-682	6800PF	50V	MYLER
C319	QET61EM-106	10MF	25V	ELECTRO
C320	QET61HM-225	2.2MF	50V	ELECTRO
C321	QET61HM-105	1MF	50V	ELECTRO
C322	QET61HM-475	4.7MF	50V	ELECTRO

B
C
F

B
C
F
D
E

Capacitors

ITEM	PART NUMBER	DESCRIPTION			
C325	QCS31HJ-180	18PF	50V	CERAMIC	D E D E D
C325	QCS31HJ-180	18PF	50V	CERAMIC	
C326	QCC31EM-473	0.047MF	25V	CERAMIC	
C326	QCC31EM-473	0.047MF	25V	CERAMIC	
C327	QCF31HP-473	0.047MF	50V	ELECTRO	E D E D E
C327	QCF31HP-473	0.047MF	50V	ELECTRO	
C328	QCT25CH-560	56PF	50V	CERAMIC	
C328	QCT25CH-560	56PF	50V	CERAMIC	
C329	QCT25CH-820	82PF	50V	CERAMIC	D E D E
C329	QCT25CH-820	82PF	50V	CERAMIC	
C330	QCT25CH-820	82PF	50V	CERAMIC	
C330	QCT25CH-820	82PF	50V	CERAMIC	
C331	QCF31HP-223	0.022MF	50V	CERAMIC	E D E D
C331	QCF31HP-223	0.022MF	50V	CERAMIC	
C332	QCF31HP-223	0.022MF	50V	CERAMIC	
C332	QCF31HP-223	0.022MF	50V	CERAMIC	
C333	QCF31HP-223	0.022MF	50V	CERAMIC	E D E D
C333	QCF31HP-223	0.022MF	50V	CERAMIC	
C334	QCS31HJ-181	180PF	50V	CERAMIC	
C334	QCS31HJ-181	180PF	50V	CERAMIC	
C335	QCS31HJ-471	470PF	50V	CERAMIC	E D E D
C335	QCS31HJ-471	470PF	50V	CERAMIC	
C336	QCF31HP-473	0.047MF	50V	ELECTRO	
C336	QCC31EM-473	0.047MF	25V	CERAMIC	
C401	QET61HM-475	4.7MF	50V	ELECTRO	E D E D
C402	QET61HM-474	0.47MF	50V	ELECTRO	
C404	QFN31HK-103	0.01MF	50V	MYLER	
C405	QFN31HK-822	8200PF	50V	MYLER	
C420	QFP31HJ-391	390PF	50V	POLY	E D E D
C421	QFN31HK-272	2700PF	50V	MYLER	
C422	QCY31HK-182	1800PF	50V	CERAMIC	
C422	QCY31HK-272	2700PF	50V	CERAMIC	
C423	QFN31HK-473	0.047MF	50V	MYLER	E D E D
C424	QET61HR-475	4.7MF	50V	ELECTRO	
C425	QEB61HM-474	0.47MF	50V	L.L.C.E.	
C426	QET61EM-106	10MF	25V	ELECTRO	
C427	QET61EM-106	10MF	25V	ELECTRO	D E D E
C428	QET61HM-225	2.2MF	50V	ELECTRO	
C429	QET61HM-475	4.7MF	50V	ELECTRO	
C430	QET61HM-475	4.7MF	50V	ELECTRO	
C431	QFN31HJ-122	1200PF	50V	MYLER	D E D E
C431	QFN31HJ-122	1200PF	50V	MYLER	
C431	QFN31HJ-122	1200PF	50V	MYLER	
C431	QFN31HJ-122	1200PF	50V	MYLER	
C431	QFN31HJ-182	1800PF	50V	MYLER	D E D E
C432	QFN31HJ-122	1200PF	50V	MYLER	
C432	QFN31HJ-122	1200PF	50V	MYLER	
C432	QFN31HJ-122	1200PF	50V	MYLER	
C432	QFN31HJ-122	1200PF	50V	MYLER	D E D E
C432	QFN31HJ-182	1800PF	50V	MYLER	
C433	QFN31HK-472	4700PF	50V	MYLER	
C434	QET51AM-477	470MF	10V	ELECTRO	
C435	QET61CM-107	100MF	16V	ELECTRO	D E D E
C436	QCS31HJ-121	120PF	50V	CERAMIC	
C436	QCS31HJ-151	150PF	50V	CERAMIC	
C436	QCS31HJ-151	150PF	50V	CERAMIC	
C436	QCS31HJ-151	150PF	50V	CERAMIC	D E D E
C436	QCS31HJ-221	220PF	50V	CERAMIC	
C436	QCS31HJ-221	220PF	50V	CERAMIC	
C437	QCS31HJ-121	120PF	50V	CERAMIC	
C437	QCS31HJ-151	150PF	50V	CERAMIC	D E D E
C437	QCS31HJ-151	150PF	50V	CERAMIC	
C437	QCS31HJ-151	150PF	50V	CERAMIC	
C437	QCS31HJ-151	150PF	50V	CERAMIC	
C437	QCS31HJ-221	220PF	50V	CERAMIC	D E D E
C437	QCS31HJ-221	220PF	50V	CERAMIC	
C721	QFN31HK-103	0.01MF	50V	MYLER	
C722	QFN31HK-103	0.01MF	50V	MYLER	
C723	QET61HM-225	2.2MF	50V	ELECTRO	D E D E
C741	QET61HM-474	0.47MF	50V	ELECTRO	
C742	QET61HM-105	1MF	50V	ELECTRO	
C743	QET61HM-474	0.47MF	50V	ELECTRO	
C801	QCF31HP-103	0.01MF	50V	CERAMIC	D E D E
C802	QCF31HP-103	0.01MF	50V	CERAMIC	
C803	QET51VM-227	220MF	35V	ELECTRO	

ITEM	PART NUMBER	DESCRIPTION			
C804	QET51HM-107	100MF	50V	ELECTRO	D E D E
C805	QET51VM-227	220MF	35V	ELECTRO	
C806	QET51VM-227	220MF	35V	ELECTRO	
C807	QET51VM-107	100MF	35V	ELECTRO	
C808	QCF31HP-103	0.01MF	50V	CERAMIC	E D E D
C809	QCF31HP-103	0.01MF	50V	CERAMIC	
C810	QET51EM-228	2200MF	25V	ELECTRO	
C811	QET61CM-226	22MF	16V	ELECTRO	
C812	QET61CM-476	47MF	16V	ELECTRO	D E D E
C813	QCF31HP-103	0.01MF	50V	CERAMIC	
C814	QET51EM-227	220MF	25V	ELECTRO	
C815	QET61AM-107	100MF	10V	ELECTRO	
C816	QET61AM-107	100MF	10V	ELECTRO	D E D E
C817	QCF31HP-103	0.01MF	50V	CERAMIC	
C818	QET51EM-477	470MF	25V	ELECTRO	
C819	QCF31HP-103	0.01MF	50V	CERAMIC	
C820	QET61AM-107	100MF	10V	ELECTRO	D E D E
C821	QET61AM-107	100MF	10V	ELECTRO	
C825	QET61EM-106	10MF	25V	ELECTRO	
C826	QET61CM-476	47MF	16V	ELECTRO	
C827	QET61EM-106	10MF	25V	ELECTRO	D E D E
C828	QET61CM-476	47MF	16V	ELECTRO	
C829	QET61EM-106	10MF	25V	ELECTRO	
C829	QET61EM-106	10MF	25V	ELECTRO	
C830	QET61CM-476	47MF	16V	ELECTRO	D E D E
C830	QET61CM-476	47MF	16V	ELECTRO	
C831	QET61CM-106	10MF	16V	ELECTRO	
C832	QET61CM-106	10MF	16V	ELECTRO	
C833	QET61CM-106	10MF	16V	ELECTRO	D E D E
C851	QCF31HP-103	0.01MF	50V	CERAMIC	
C852	QCF31HP-103	0.01MF	50V	CERAMIC	
TC121	ENZ1003-003			TRIMMER	
TC122	ENZ1003-003			TRIMMER	
TC123	ENZ1003-003			TRIMMER	
TC124	ENZ1003-003			TRIMMER	
TC301	ENZ1003-002			TRIMMER	
TC302	ENZ1003-002			TRIMMER	
TC321	ENZ1003-006			TRIMMER	
TC321	ENZ1003-006			TRIMMER	
TC322	ENZ1003-006			TRIMMER	
TC322	ENZ1003-006			TRIMMER	

Resistors

ITEM	PART NUMBER	DESCRIPTION			
R101	QRD141J-152S	1.5K	1/4W	CARBON	D E D E
R102	QRD141J-152S	1.5K	1/4W	CARBON	
R103	QRD141J-103S	10K	1/4W	CARBON	
R104	QRD141J-331S	330	1/4W	CARBON	
R105	QRD141J-473S	47K	1/4W	CARBON	D E D E
R106	QRD141J-473S	47K	1/4W	CARBON	
R107	QRD141J-104S	100K	1/4W	CARBON	
R108	QRD141J-152S	1.5K	1/4W	CARBON	
R109	QRD141J-152S	1.5K	1/4W	CARBON	D E D E
R110	QRD141J-152S	1.5K	1/4W	CARBON	
R111	QRD141J-152S	1.5K	1/4W	CARBON	
R112	QRD141J-473S	47K	1/4W	CARBON	
R113	QRD141J-103S	10K	1/4W	CARBON	D E D E
R114	QRD141J-561S	560	1/4W	CARBON	
R115	QRC128K-105EM	1M	1/2W	COMPOSI	
R116	QRC128K-105EM	1M	1/2W	COMPOSI	
R121	QRD141J-473S	47K	1/4W	CARBON	D E D E
R122	QRD141J-473S	47K	1/4W	CARBON	
R123	QRD141J-473S	47K	1/4W	CARBON	
R124	QRD141J-563S	56K	1/4W	CARBON	
R125	QRD141J-680S	68	1/4W	CARBON	D E D E
R126	QRD141J-101S	100	1/4W	CARBON	
R127	QRD141J-473S	47K	1/4W	CARBON	
R128	QRD141J-473S	47K	1/4W	CARBON	
R129	QRD141J-473S	47K	1/4W	CARBON	D E D E
R130	QRD141J-104S	100K	1/4W	CARBON	
R131	QRD141J-562S	5.6K	1/4W	CARBON	

▲ Safety Parts

Resistors

ITEM	PART NUMBER	DESCRIPTION	
R132	QRD141J-560S	56	1/4W CARBON
R133	QRD148J-100S	10	1/4W CARBON
R134	QRD141J-181S	180	1/4W CARBON
R135	QRD141J-331S	330	1/4W CARBON
R136	QRD141J-103S	10K	1/4W CARBON
R137	QRD141J-331S	330	1/4W CARBON
R138	QRD141J-102S	1K	1/4W CARBON
R139	QRD141J-822S	8.2K	1/4W CARBON
R140	QRD141J-682S	6.8K	1/4W CARBON
R141	QRD141J-562S	5.6K	1/4W CARBON
R142	QRD141J-224S	220K	1/4W CARBON
R143	QRD141J-331S	330	1/4W CARBON
R144	QRD141J-331S	330	1/4W CARBON
R201	QRD141J-181S	180	1/4W CARBON
R202	QRD141J-102S	1K	1/4W CARBON
R203	QRD141J-102S	1K	1/4W CARBON
R204	QRD141J-102S	1K	1/4W CARBON
R205	QRD141J-392S	3.9K	1/4W CARBON
R206	QRD141J-332S	3.3K	1/4W CARBON
R207	QRD141J-682S	6.8K	1/4W CARBON
R208	QRD141J-102S	1K	1/4W CARBON
R209	QRD141J-152S	1.5K	1/4W CARBON
R210	QRD141J-472S	4.7K	1/4W CARBON
R211	QRD141J-103S	10K	1/4W CARBON
R212	QRD141J-272S	2.7K	1/4W CARBON
R213	QRD141J-331S	330	1/4W CARBON
R214	QRD141J-271S	270	1/4W CARBON
R215	QRD141J-331S	330	1/4W CARBON
R216	QRD141J-272S	2.7K	1/4W CARBON
R217	QRD141J-471S	470	1/4W CARBON
R218	QRD141J-331S	330	1/4W CARBON
R219	QRD141J-681S	680	1/4W CARBON
R220	QRD141J-472S	4.7K	1/4W CARBON
R221	QRD141J-103S	10K	1/4W CARBON
R222	QRD141J-102S	1K	1/4W CARBON
R223	QRD141J-273S	27K	1/4W CARBON
R224	QRD141J-472S	4.7K	1/4W CARBON
R225	QRD141J-331S	330	1/4W CARBON
R226	QRD141J-681S	680	1/4W CARBON
R227	QRD141J-103S	10K	1/4W CARBON
R228	QRD141J-332S	3.3K	1/4W CARBON
R229	QRD141J-472S	4.7K	1/4W CARBON
R230	QRD141J-332S	3.3K	1/4W CARBON
R231	QRD141J-332S	3.3K	1/4W CARBON
R241	QRD141J-331S	330	1/4W CARBON
R242	QRD141J-103S	10K	1/4W CARBON
R243	QRD141J-821S	820	1/4W CARBON
R244	QRD141J-103S	10K	1/4W CARBON
R244	QRD141J-103S	10K	1/4W CARBON
R244	QRD141J-153S	15K	1/4W CARBON
R244	QRD141J-153S	15K	1/4W CARBON
R244	QRD141J-153S	15K	1/4W CARBON
R244	QRD141J-153S	15K	1/4W CARBON
R245	QRD141J-272S	2.7K	1/4W CARBON
R246	QRD141J-104S	100K	1/4W CARBON
R247	QRD141J-683S	68K	1/4W CARBON
R248	QRD141J-562S	5.6K	1/4W CARBON
R301	QRD141J-223S	22K	1/4W CARBON
R302	QRD141J-473S	47K	1/4W CARBON
R303	QRD141J-151S	150	1/4W CARBON
R304	QRD141J-152S	1.5K	1/4W CARBON
R305	QRD141J-222S	2.2K	1/4W CARBON
R306	QRD141J-331S	330	1/4W CARBON
R307	QRD141J-153S	15K	1/4W CARBON
R308	QRD141J-123S	12K	1/4W CARBON
R309	QRD141J-104S	100K	1/4W CARBON
R310	QRD141J-101S	100	1/4W CARBON
R311	QRD141J-103S	10K	1/4W CARBON
R312	QRD141J-223S	22K	1/4W CARBON
R313	QRD141J-223S	22K	1/4W CARBON
R314	QRD141J-103S	10K	1/4W CARBON
R315	QRD141J-820S	82	1/4W CARBON
R316	ERT-D2WFL351S		MATSUSHITA
R320	QRD141J-473S	47K	1/4W CARBON
R320	QRD141J-473S	47K	1/4W CARBON

ITEM	PART NUMBER	DESCRIPTION	
R321	QRD141J-473S	47K	1/4W CARBON
R321	QRD141J-473S	47K	1/4W CARBON
R322	QRD141J-472S	4.7K	1/4W CARBON
R322	QRD141J-472S	4.7K	1/4W CARBON
R323	QRD141J-105S	1M	1/4W CARBON
R323	QRD141J-105S	1M	1/4W CARBON
R324	QRD141J-331S	330	1/4W CARBON
R324	QRD141J-331S	330	1/4W CARBON
R325	QRD141J-103S	10K	1/4W CARBON
R325	QRD141J-103S	10K	1/4W CARBON
R326	QRD141J-103S	10K	1/4W CARBON
R326	QRD141J-103S	10K	1/4W CARBON
R327	QRD141J-563S	56K	1/4W CARBON
R327	QRD141J-563S	56K	1/4W CARBON
R328	QRD141J-223S	22K	1/4W CARBON
R328	QRD141J-223S	22K	1/4W CARBON
R329	QRD141J-473S	47K	1/4W CARBON
R329	QRD141J-473S	47K	1/4W CARBON
R331	QRD141J-104S	100K	1/4W CARBON
R331	QRD141J-104S	100K	1/4W CARBON
R332	QRD141J-104S	100K	1/4W CARBON
R332	QRD141J-104S	100K	1/4W CARBON
R333	QRD141J-332S	3.3K	1/4W CARBON
R333	QRD141J-332S	3.3K	1/4W CARBON
R334	QRD141J-332S	3.3K	1/4W CARBON
R334	QRD141J-332S	3.3K	1/4W CARBON
R334	QRD141J-332S	3.3K	1/4W CARBON
R401	QRD141J-392S	3.9K	1/4W CARBON
R402	QRD141J-103S	10K	1/4W CARBON
R403	QRD141J-153S	15K	1/4W CARBON
R403	QRD141J-153S	15K	1/4W CARBON
R403	QRD141J-153S	15K	1/4W CARBON
R403	QRD141J-153S	15K	1/4W CARBON
R403	QRD141J-223S	22K	1/4W CARBON
R403	QRD141J-223S	22K	1/4W CARBON
R404	QRD141J-103S	10K	1/4W CARBON
R404	QRD141J-103S	10K	1/4W CARBON
R405	QRD141J-473S	47K	1/4W CARBON
R406	QRD141J-102S	1K	1/4W CARBON
R407	QRD148J-475S	4.7M	1/4W CARBON
R408	QRD141J-562S	5.6K	1/4W CARBON
R409	QRD141J-473S	47K	1/4W CARBON
R410	QRD148J-475S	4.7M	1/4W CARBON
R411	QRD141J-562S	5.6K	1/4W CARBON
R412	QRD148J-225S	2.2M	1/4W CARBON
R413	QRD141J-104S	100K	1/4W CARBON
R414	QRD141J-473S	47K	1/4W CARBON
R415	QRD141J-103S	10K	1/4W CARBON
R415	QRD141J-103S	10K	1/4W CARBON
R416	QRD141J-103S	10K	1/4W CARBON
R416	QRD141J-103S	10K	1/4W CARBON
R417	QRD141J-331S	330	1/4W CARBON
R420	QRD141J-183S	18K	1/4W CARBON
R421	QRD141J-105S	1M	1/4W CARBON
R422	QRD141J-823S	82K	1/4W CARBON
R423	QRD141J-471S	470	1/4W CARBON
R424	QRD141J-103S	10K	1/4W CARBON
R425	QRD141J-332S	3.3K	1/4W CARBON
R426	QRD141J-332S	3.3K	1/4W CARBON
R427	QRD141J-333S	33K	1/4W CARBON
R428	QRD141J-333S	33K	1/4W CARBON
R429	QRD141J-333S	33K	1/4W CARBON
R430	QRD141J-333S	33K	1/4W CARBON
R431	QRD141J-563S	56K	1/4W CARBON
R432	QRD141J-223S	22K	1/4W CARBON
R433	QRD141J-472S	4.7K	1/4W CARBON
R434	QRD141J-472S	4.7K	1/4W CARBON
R435	QRD141J-223S	22K	1/4W CARBON
R436	QRD141J-473S	47K	1/4W CARBON
R437	QRD141J-473S	47K	1/4W CARBON
R438	QRD141J-223S	22K	1/4W CARBON
R439	QRD141J-223S	22K	1/4W CARBON
R440	QRD141J-101S	100	1/4W CARBON
R441	QRD141J-101S	100	1/4W CARBON
R442	QRD141J-682S	6.8K	1/4W CARBON

Resistors

ITEM	PART NUMBER	DESCRIPTION	
R443	QRD141J-682S	6.8K	1/4W CARBON
R444	QRD141J-561S	560	1/4W CARBON
R445	QRD141J-821S	820	1/4W CARBON
R446	QRD141J-334S	330K	1/4W CARBON
R447	QRD141J-334S	330K	1/4W CARBON
R448	QRD141J-334S	330K	1/4W CARBON
R449	QRD141J-562S	5.6K	1/4W CARBON
R450	QRD141J-472S	4.7K	1/4W CARBON
R451	QRD141J-224S	220K	1/4W CARBON
R452	QRD141J-224S	220K	1/4W CARBON
R701	QRD141J-682S	6.8K	1/4W CARBON
R702	QRD141J-392S	3.9K	1/4W CARBON
R703	QRD141J-682S	6.8K	1/4W CARBON
R704	QRD141J-473S	47K	1/4W CARBON
R705	QRD141J-682S	6.8K	1/4W CARBON
R706	QRD141J-562S	5.6K	1/4W CARBON
R707	QRD141J-223S	22K	1/4W CARBON
R708	QRD141J-473S	47K	1/4W CARBON
R709	QRD141J-682S	6.8K	1/4W CARBON
R710	QRD141J-473S	47K	1/4W CARBON
R721	QRD141J-103S	10K	1/4W CARBON
R722	QRD141J-153S	15K	1/4W CARBON
R723	QRD141J-563S	56K	1/4W CARBON
R724	QRD141J-103S	10K	1/4W CARBON
R725	QRD141J-332S	3.3K	1/4W CARBON
R726	QRD141J-563S	56K	1/4W CARBON
R727	QRD141J-103S	10K	1/4W CARBON
R728	QRD141J-153S	15K	1/4W CARBON
R729	QRD141J-104S	100K	1/4W CARBON
R730	QRD141J-104S	100K	1/4W CARBON
R731	QRD141J-104S	100K	1/4W CARBON
R732	QRD141J-104S	100K	1/4W CARBON
R741	QRD141J-223S	22K	1/4W CARBON
R742	QRD141J-473S	47K	1/4W CARBON
R743	QRD141J-473S	47K	1/4W CARBON
R744	QRD141J-473S	47K	1/4W CARBON
R745	QRD141J-103S	10K	1/4W CARBON
R746	QRD141J-104S	100K	1/4W CARBON
R801	QRD141J-272S	2.7K	1/4W CARBON
R802	QRZ0062-100	10	△ 1/4W FUSIBLE
R803	QRD141J-562S	5.6K	1/4W CARBON
R804	QRD141J-562S	5.6K	1/4W CARBON
R805	QRD141J-221S	220	1/4W CARBON
R806	QRD141J-103S	10K	1/4W CARBON
R807	QRD141J-102S	1K	1/4W CARBON
R808	QRD141J-101S	100	1/4W CARBON
R809	QRD141J-221S	220	1/4W CARBON
R810	QRD141J-102S	1K	1/4W CARBON
R811	QRD125J-270	27	△ 1/2W UNF. CARBON
R812	QRD125J-270	27	△ 1/2W UNF. CARBON
R813	QRD141J-221S	220	1/4W CARBON
R814	QRD141J-221S	220	1/4W CARBON
R815	QRD141J-101S	100	1/4W CARBON
R816	QRZ0062-180	18	1/4W FUSIBLE
R821	QRZ0062-180	18	△ 1/4W FUSIBLE
R822	QRD141J-103S	10K	1/4W CARBON
R823	QRD141J-103S	10K	1/4W CARBON
R824	QRZ0062-180	18	△ 1/4W FUSIBLE
R825	QRD141J-103S	10K	1/4W CARBON
R826	QRD141J-103S	10K	1/4W CARBON
R827	QRZ0062-180	18	△ 1/4W FUSIBLE
R827	QRZ0062-180	18	△ 1/4W FUSIBLE
R828	QRD141J-103S	10K	1/4W CARBON
R828	QRD141J-103S	10K	1/4W CARBON
R829	QRD141J-103S	10K	1/4W CARBON
R829	QRD141J-103S	10K	1/4W CARBON
R829	QRD141J-103S	10K	1/4W CARBON
R830	QRD141J-103S	10K	1/4W CARBON
R830	GRC128K-275EM	2.7M	△ 1/2W COMPOSI
R831	QRD141J-223S	22K	1/4W CARBON
R832	QRD141J-221S	220	1/4W CARBON
VR241	QVP4A0B-223	22K	0.1W VALIABLE
VR242	QVP4A0B-473	47K	0.1W VALIABLE
VR301	QVP4A0B-473	47K	0.1W VALIABLE
VR401	QVP4A0B-103	10K	0.1W VALIABLE
VR421	QVP4A0B-224	220K	0.1W VALIABLE
VR422	QVP4A0B-103	10K	0.1W VALIABLE
VR423	QVZ3518-224	220K	VALIABLE

Others

ITEM	PART NUMBER	DESCRIPTION
	EMN00TV-201A	2P PIN JACK
	EMB91YV-101A	ANTENNA CONECTOR
	EMB91YV-101A	ANTENNA CONECTOR
	EMB91YV-101A	ANTENNA CONECTOR
	EMB91YV-102A	ANTENNA CONECTOR
	EMB91YV-102A	ANTENNA CONECTOP
	EMB01YV-201A	ANTENNA TERMINAL
	E03572-019F	ANTENNA TERMINAL
	E03572-019F	ANTENNA TERMINAL
	E03572-019P	ANTENNA TERMINAL
	E67764-006	WRAPPING TERMINAL
	E67764-006	WRAPPING TERMINAL
	E67764-103	WRAPPING TERMINAL
	E65508-002	TAB
	E65508-002	TAB
	E10909-101	CIRCUIT BOARD
	E70859-001	EARTH PLATE
	E71203-001	SHIELD PLATE
	E69328-001	SHIELD COVER
L401	EQF0102-001	FILTER
L401	EQF0102-001	FILTER
L401	EQF0102-001	FILTER
L401	EQF0102-001	FILTER
L401	EQF0102-001	FILTER
L421	EQF0101-003	L.P.FILTER
S801	QST4101-E01	PUSH SWITCH
CF201	ECB2118-004R	CERAMIC FILTER
CF202	ECB2118-004R	CERAMIC FILTER
CF203	ECB2125-003R	CERAMIC FILTER
CF301	ECB1117-001	CERAMIC FILTER
CF302	ECB1001-001	CERAMIC FILTER
RT301	E67764-004	WRAPPING TERMINAL
RT301	E67764-004	WRAPPING TERMINAL
RT301	E67764-004	WRAPPING TERMINAL
RT801	E67764-104	TERMINAL
RT802	E67764-105	TERMINAL
RT803	E67764-103	WRAPPING TERMINAL
RT804	E67764-102	TERMINAL ASS'Y
RT805	E67764-102	TERMINAL ASS'Y
RT806	E67764-102	TERMINAL ASS'Y
RT807	E67764-102	TERMINAL ASS'Y
RT808	E67764-104	TERMINAL
RT809	E67764-104	TERMINAL
RY101	ESK2D05-111	RELAY
TP201	E67764-002	TERMINAL ASS'Y
TP401	E67764-002	TERMINAL ASS'Y
TP701	E67764-103	WRAPPING TERMINAL

3-(2) ENB-006 □ Logic(1) P.C. Board Ass'y

Note: ENB-006 □ varies according to the areas employed. See note(1) when placing an order.

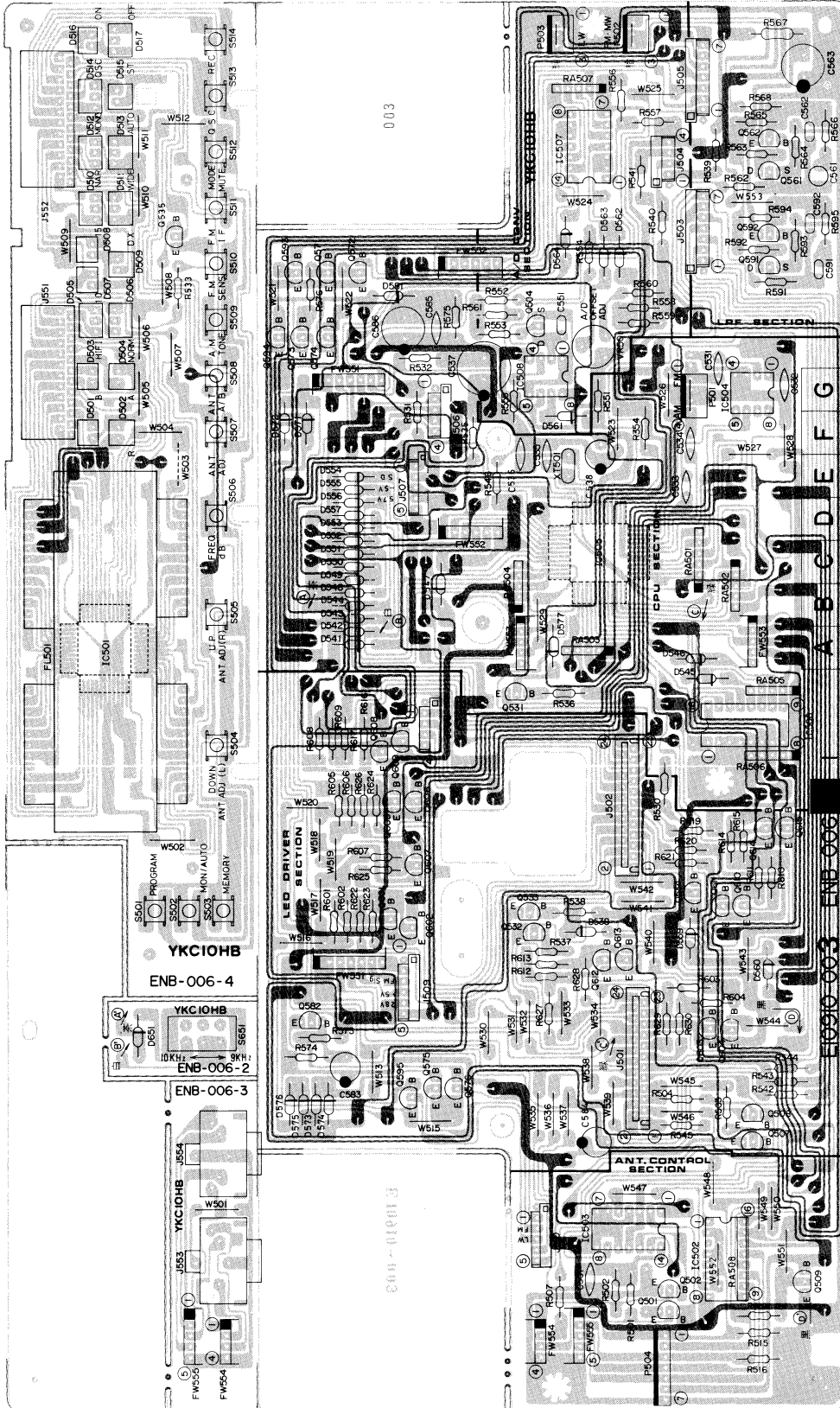

Note(1)

Designated Areas	P.C.Board Ass'y
U.S.A., Canada	ENB-006 B
U.S. Military, Market Other countries	ENB-006 C
Europe, Spain, U.K. West Germany	ENB-006 D
Australia	ENB-006 E

Note(2)

The symbols(赤、黒、白……etc.) on P.C.Board surface are factory process only.

The Marks for Designated Areas	
B	U.S.A., Canada
C	U.S. Military, Market Other Countries
D	Europe, Spain, U.K. West Germany
E	Australia

Transistors

ITEM	PART NUMBER	DESCRIPTION	
		M A K E R	
Q504	2SA564A(R)	SILICON	MATSUSHITA
Q504	2SK105(F)	F.E.T.	NEC
Q505	DTC114Y	SILICON	ROHM
Q506	2SA564A(R)	SILICON	MATSUSHITA
Q509	DTC114YN	SILICON	ROHM
Q531	2SC458(C,D)	SILICON	HITACHI
Q532	2SC458(C,D)	SILICON	HITACHI
Q534	2SA1029(C)	SILICON	HITACHI
Q535	2SC458(C)	SILICON	HITACHI
Q561	2SK105(F)	F.E.T.	NEC
Q562	2SC458(C)	SILICON	HITACHI
Q571	DTC114Y	SILICON	ROHM
Q572	DTC114Y	SILICON	ROHM
Q573	2SB562(C)	SILICON	HITACHI
Q574	DTA114YN	SILICON	ROHM
Q575	DTC114YN	SILICON	ROHM
Q576	DTC114YN	SILICON	ROHM
Q581	2SA1029(C)	SILICON	HITACHI
Q582	2SC458(C,D)	SILICON	HITACHI
Q591	2SK105(F)	F.E.T.	NEC
Q592	2SC458(C)	SILICON	HITACHI
Q593	DTC114Y	SILICON	ROHM
Q594	DTA114YN	SILICON	ROHM
Q595	DTC114YN	SILICON	ROHM
Q601	DTC114Y	SILICON	ROHM
Q602	DTC114Y	SILICON	ROHM
Q603	DTC114Y	SILICON	ROHM
Q604	DTC114Y	SILICON	ROHM
Q605	DTC114Y	SILICON	ROHM
Q606	DTC114Y	SILICON	ROHM

ITEM	PART NUMBER	DESCRIPTION	
		M A K E R	
Q607	DTC114Y	SILICON	ROHM
Q608	DTC114Y	SILICON	ROHM
Q609	DTC114Y	SILICON	ROHM
Q610	DTC114Y	SILICON	ROHM
Q611	DTC114Y	SILICON	ROHM
Q612	DTC114Y	SILICON	ROHM
Q613	DTC114Y	SILICON	ROHM
Q614	DTC114Y	SILICON	ROHM
Q615	DTC114Y	SILICON	ROHM

ICs

ITEM	PART NUMBER	DESCRIPTION	
		M A K E R	
IC501	UPD6320G		NEC
IC502	HD14503BP		HITACHI
IC504	UPB553AC		NEC
IC505	UPD1707G-516-00		NEC
IC506	MN1203		MATSUSHITA
IC507	TC4066BP		TOSHIBA
IC508	AN6552		MATSUSHITA

Diodes

ITEM	PART NUMBER	DESCRIPTION	
		M A K E R	
D503	LD-101DW	SILICON	ROHM
D504	LD-101DW	SILICON	ROHM
D505	LD-001DW	SILICON	ROHM
D506	LD-001DW	SILICON	ROHM
D507	LD-101DW	SILICON	ROHM
D508	LD-101DW	SILICON	ROHM
D509	LD-101VW	SILICON	ROHM
D510	LD-001DW	SILICON	ROHM
D511	LD-001DW	SILICON	ROHM
D512	LD-001VW	SILICON	ROHM
D513	LD-001DW	SILICON	ROHM
D514	LD-001DW	SILICON	ROHM
D515	LD-101VW	SILICON	ROHM
D516	LD-101DW	SILICON	ROHM
D517	LD-001DW	SILICON	ROHM
D518	LD6031	SILICON	ROHM
D519	LD6031	SILICON	ROHM
D520	LD6031	SILICON	ROHM
D521	LD6031	SILICON	ROHM
D522	LD6031	SILICON	ROHM
D523	LD6031	SILICON	ROHM
D524	LD6031	SILICON	ROHM
D525	LD6031	SILICON	ROHM
D526	LD6031	SILICON	ROHM
D527	LD6031	SILICON	ROHM
D528	LD-101DW	SILICON	ROHM
D529	LD-101VW	SILICON	ROHM
D533	1S2076-31	SILICON	HITACHI
D534	1S2076-31	SILICON	HITACHI
D537	RD5.1EB3	SILICON	NEC
D538	RD5.1EB3	SILICON	NEC
D539	1S2076-31	SILICON	HITACHI
D541	1S2076-31	SILICON	HITACHI
D542	1S2076-31	SILICON	HITACHI
D543	1S2076-31	SILICON	HITACHI
D544	1S2076-31	SILICON	HITACHI
D545	1S2076-31	SILICON	HITACHI
D546	1S2076-31	SILICON	HITACHI
D547	1S2076-31	SILICON	HITACHI
D548	1S2076-31	SILICON	HITACHI
D548	1S2076-31	SILICON	HITACHI

Diodes

ITEM	PART NUMBER	DESCRIPTION	
			M A K E R
D548	1S2076-31	SILICON	HITACHI
D549	1S2076-31	SILICON	HITACHI
D550	1S2076-31	SILICON	HITACHI
D551	1S2076-31	SILICON	HITACHI
D552	1S2076-31	SILICON	HITACHI
D553	1S2076-31	SILICON	HITACHI
D554	1S2076-31	SILICON	HITACHI
D556	1S2076-31	SILICON	HITACHI
D557	1S2076-31	SILICON	HITACHI
D559	1S2076-31	SILICON	HITACHI
D560	1S2076-31	SILICON	HITACHI
D561	1S2076-31	SILICON	HITACHI
D562	1S2076-31	SILICON	HITACHI
D564	1S2076-31	SILICON	HITACHI
D571	1S2076-31	SILICON	HITACHI
D572	1S2076-31	SILICON	HITACHI
D573	1S2076-31	SILICON	HITACHI
D574	1S2076-31	SILICON	HITACHI
D575	1S2076-31	SILICON	HITACHI
D576	1S2076-31	SILICON	HITACHI
D581	1S2076-31	SILICON	HITACHI
D651	1S2076-31	SILICON	HITACHI
D651	1S2076-31	SILICON	HITACHI
D651	1S2076-31	SILICON	HITACHI

Capacitors

ITEM	PART NUMBER	DESCRIPTION		
C531	QCS31HJ-101	100PF	50V	CERAMIC
C532	QCF31HP-223	0.022MF	50V	CERAMIC
C533	QCY31HK-102	1000PF	50V	CERAMIC
C534	QCY31HK-102	1000PF	50V	CERAMIC
C535	QCS31HJ-22C	22PF	50V	CERAMIC
C536	QCS31HJ-220	22PF	50V	CERAMIC
C537	EEZ0501-229	0.022F	5.5V	ELECTRO
C538	QCF31HP-223	0.022MF	50V	CERAMIC
C539	QET51EM-106	10MF	25V	ELECTRO
C540	QCF31HP-223	0.022MF	50V	CERAMIC
C551	QFN81HK-104	0.1MF	50V	MYLER
C561	QEN51HM-225	2.2MF	50V	NON POLE
C562	QCY31HK-102	1000PF	50V	CERAMIC
C563	QET51VM-107	100MF	35V	ELECTRO
C581	QET61EM-106	10MF	25V	ELECTRO
C582	QET51EM-476	47MF	25V	ELECTRO
C582	QET61EM-106	10MF	25V	ELECTRO
C583	QET61EM-106	10MF	25V	ELECTRO
C584	QET61EM-106	10MF	25V	ELECTRO
C585	QCF31HP-223	0.022MF	50V	CERAMIC
C586	QET50JM-477	470PF	63V	ELECTRO
C591	QFN81HK-104	0.1MF	50V	MYLER
C592	QFN31HK-472	4700PF	50V	MYLER

Resistors

ITEM	PART NUMBER	DESCRIPTION		
R501	QRD141J-562S	5.6K	1/4W	CARBON
R502	QRD141J-562S	5.6K	1/4W	CARBON
R509	QRD141J-471S	470	1/4W	CARBON
R510	QRD141J-471S	470	1/4W	CARBON
R514	QRD141J-471S	470	1/4W	CARBON
R515	QRD141J-223S	22K	1/4W	CARBON
R516	QRD141J-223S	22K	1/4W	CARBON
R518	QRD141J-102S	1K	1/4W	CARBON
R519	QRD141J-103S	10K	1/4W	CARBON
R530	QRD141J-334S	330K	1/4W	CARBON
R531	QRD141J-103S	10K	1/4W	CARBON
R532	QRD141J-102S	1K	1/4W	CARBON
R532	QRD141J-102S	1K	1/4W	CARBON
R533	QRD141J-221S	220	1/4W	CARBON
R533	QRD141J-334S	330K	1/4W	CARBON

ITEM	PART NUMBER	DESCRIPTION		
R534	QRD141J-563S	56K	1/4W	CARBON
R535	QRD141J-103S	10K	1/4W	CARBON
R536	QRD141J-334S	330K	1/4W	CARBON
R537	QRD141J-334S	330K	1/4W	CARBON
R539	QRD141J-122S	1.2K	1/4W	CARBON
R540	QRD141J-471S	470	1/4W	CARBON
R541	QRD141J-471S	470	1/4W	CARBON
R542	QRD141J-101S	100	1/4W	CARBON
R543	QRD141J-101S	100	1/4W	CARBON
R544	QRD141J-101S	100	1/4W	CARBON
R545	QRD141J-101S	100	1/4W	CARBON
R546	QRD141J-223S	22K	1/4W	CARBON
R551	QRD141J-103S	10K	1/4W	CARBON
R552	QRD141J-562S	5.6K	1/4W	CARBON
R553	QRD148J-475S	4.7M	1/4W	CARBON
R554	QRD141J-563S	56K	1/4W	CARBON
R555	QRD141J-103S	10K	1/4W	CARBON
R556	QRD141J-103S	10K	1/4W	CARBON
R557	QRD141J-472S	4.7K	1/4W	CARBON
R558	QRD141J-223S	22K	1/4W	CARBON
R559	QRD141J-562S	5.6K	1/4W	CARBON
R560	QRD141J-103S	10K	1/4W	CARBON
R561	QRD141J-563S	56K	1/4W	CARBON
R562	QRD141J-102S	1K	1/4W	CARBON
R563	QRD141J-222S	2.2K	1/4W	CARBON
R564	QRD141J-331S	330	1/4W	CARBON
R565	QRD141J-682S	6.8K	1/4W	CARBON
R566	QRD141J-392S	3.9K	1/4W	CARBON
R567	QRD125J-680	68	1/2W	UNF. CARBON
R568	QRD141J-473S	47K	1/4W	CARBON
R571	QRD141J-562S	5.6K	1/4W	CARBON
R572	QRD141J-472S	4.7K	1/4W	CARBON
R573	QRD141J-103S	10K	1/4W	CARBON
R574	QRD141J-183S	18K	1/4W	CARBON
R575	QRD141J-223S	22K	1/4W	CARBON
R576	QRD141J-472S	4.7K	1/4W	CARBON
R591	QRD141J-222S	2.2K	1/4W	CARBON
R592	QRD141J-222S	2.2K	1/4W	CARBON
R593	QRD141J-331S	330	1/4W	CARBON
R594	QRD141J-682S	6.8K	1/4W	CARBON
R595	QRD141J-333S	33K	1/4W	CARBON
R596	QRD141J-473S	47K	1/4W	CARBON
R601	QRD141J-332S	3.3K	1/4W	CARBON
R602	QRD141J-332S	3.3K	1/4W	CARBON
R603	QRD141J-332S	3.3K	1/4W	CARBON
R604	QRD141J-332S	3.3K	1/4W	CARBON
R605	QRD141J-332S	3.3K	1/4W	CARBON
R606	QRD141J-332S	3.3K	1/4W	CARBON
R607	QRD141J-332S	3.3K	1/4W	CARBON
R608	QRD141J-332S	3.3K	1/4W	CARBON
R609	QRD141J-332S	3.3K	1/4W	CARBON
R610	QRD141J-332S	3.3K	1/4W	CARBON
R611	QRD141J-332S	3.3K	1/4W	CARBON
R612	QRD141J-332S	3.3K	1/4W	CARBON
R613	QRD141J-332S	3.3K	1/4W	CARBON
R614	QRD141J-332S	3.3K	1/4W	CARBON
R615	QRD141J-332S	3.3K	1/4W	CARBON
R616	QRD141J-101S	100	1/4W	CARBON
R617	QRD141J-221S	220	1/4W	CARBON
R618	QRD141J-101S	100	1/4W	CARBON
R619	QRD141J-101S	100	1/4W	CARBON
R620	QRD141J-101S	100	1/4W	CARBON
R621	QRD141J-101S	100	1/4W	CARBON
R622	QRD141J-101S	100	1/4W	CARBON
R623	QRD141J-101S	100	1/4W	CARBON
R624	QRD141J-221S	220	1/4W	CARBON
R625	QRD141J-221S	220	1/4W	CARBON
R626	QRD141J-221S	220	1/4W	CARBON
R627	QRD141J-390S	39	1/4W	CARBON
R628	QRD141J-390S	39	1/4W	CARBON
R629	QRD141J-221S	220	1/4W	CARBON
R630	QRD141J-221S	220	1/4W	CARBON
R631	QRD141J-221S	220	1/4W	CARBON
R632	QRD141J-221S	220	1/4W	CARBON
VR501	QVP4A0B-223	22K	0.1W	BALIABLE

Others

ITEM	PART NUMBER	DESCRIPTION
	E04365-004	JAMPER SOCKET
	E04365-004	JAMPER SOCKET
	E04365-004	JAMPER SOCKET
	E04365-005	FLAT WIRE SOCKET
	E04365-005	FLAT WIRE SOCKET
	E04365-005	FLAT WIRE SOCKET
	E04365-007	FLAT WIRE SOCKET
	E04365-007	FLAT WIRE SOCKET
	E04371-024A	SOCKET
	E04371-024B	SOCKET
	E04365-006	6P CONNECTOR
	E10910-003	CIRCUIT BOARD
	E10910-101	CIRCUIT BOARD
	E10910-101	CIRCUIT BOARD
	E10910-101	CIRCUIT BOARD
	E66554-002	THROUT PIN
	E302973-001	L.E.D.HOLDER
	EX0027005N40S	SPACER
	EX0085013H05S	SPACER
J553	EMC0589-001	DIN CONNECT
P501	QMV5005-004K	4P PLUG ASS'Y
P502	QMV5005-003K	3P PLUG ASS'Y
P503	QMV5005-003K	3P PLUG ASS'Y
P504	QMV5005-007K	PLUG ASS'Y
S501	ESP0001-007	PUSH SWITCH
S502	ESP0001-007	PUSH SWITCH
S503	ESP0001-007	PUSH SWITCH
S504	ESP0001-007	PUSH SWITCH
S505	ESP0001-007	PUSH SWITCH
S506	ESP0001-007	PUSH SWITCH
S508	ESP0001-007	PUSH SWITCH
S509	ESP0001-007	PUSH SWITCH
S510	ESP0001-007	PUSH SWITCH
S511	ESP0001-007	PUSH SWITCH
S512	ESP0001-007	PUSH SWITCH
S513	ESP0001-007	PUSH SWITCH
S514	ESP0001-007	PUSH SWITCH
S515	ESP0001-007	PUSH SWITCH
S516	ESP0001-007	PUSH SWITCH
S517	ESP0001-007	PUSH SWITCH
S518	ESP0001-007	PUSH SWITCH
S519	ESP0001-007	PUSH SWITCH
S520	ESP0001-007	PUSH SWITCH
S521	ESP0001-007	PUSH SWITCH
S522	ESP0001-007	PUSH SWITCH
S523	ESP0001-007	PUSH SWITCH
S524	ESP0001-007	PUSH SWITCH
S525	ESP0001-007	PUSH SWITCH
S651	QSS2201-002	SLIDE SWITCH
S651	QSS2201-002	SLIDE SWITCH
XT501	ECX0004-500KC	CRYSTAL
FL501	ELU0001-021	F. L TUBE
RA501	ERGS5XK-103	RESISTOR ARRAY
RA502	ERGS4XK-103	RESISTOR ARRAY
RA503	ERGS4XK-103	RESISTOR ARRAY
RA504	ERGS4XK-223	RESISTOR ARRAY
RA505	ERGS4XK-223	RESISTOR ARRAY
RA506	ERGS4XK-223	RESISTOR ARRAY
RA507	ERGS4XK-334	RESISTOR ARRAY
RA508	ERGS4YK-470	RESISTOR ARRAY

D

B
C

3-(3) ENB-012A Logic(1) P.C. Board Ass'y

Note: ENB-012A varies according to the areas employed. See note(1) when placing an order.

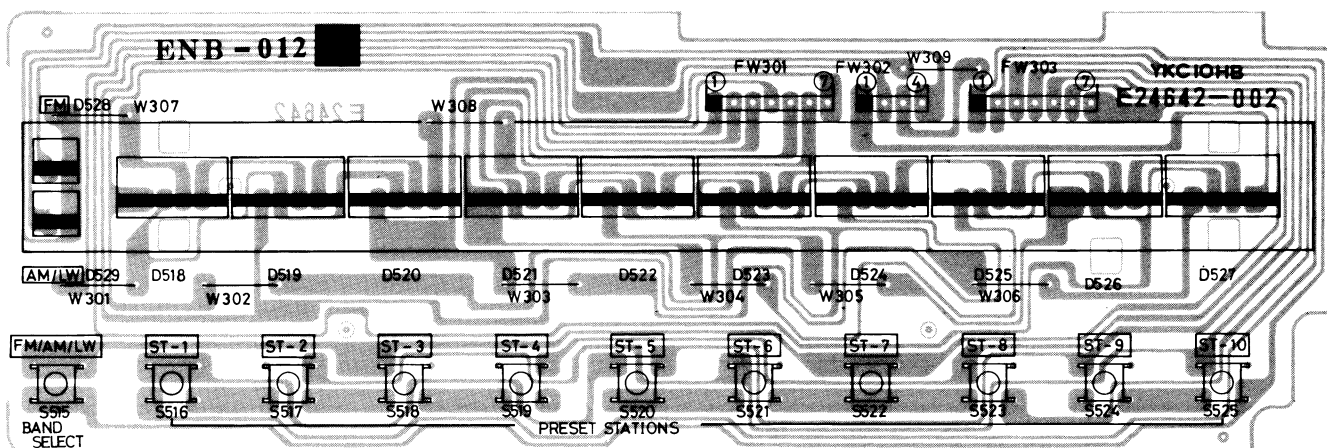

ITEM	PART NUMBER	DESCRIPTION	
			MAKER
D518	LD6031	L. E. D.	ROHM
D519	LD6031	L. E. D.	ROHM
D520	LD6031	L. E. D.	ROHM
D521	LD6031	L. E. D.	ROHM
D522	LD6031	L. E. D.	ROHM
D523	LD6031	L. E. D.	ROHM
D524	LD6031	L. E. D.	ROHM
D525	LD6031	L. E. D.	ROHM
D526	LD6031	L. E. D.	ROHM
D527	LD6031	L. E. D.	ROHM
D528	LD-101VW	L. E. D.	ROHM
D529	LD-101VW	L. E. D.	ROHM

ITEM	PART NUMBER	DESCRIPTION
S515	ESP0001-007	PUSH SWITCH
S516	ESP0001-007	PUSH SWITCH
S517	ESP0001-007	PUSH SWITCH
S518	ESP0001-007	PUSH SWITCH
S519	ESP0001-007	PUSH SWITCH
S520	ESP0001-007	PUSH SWITCH
S521	ESP0001-007	PUSH SWITCH
S522	ESP0001-007	PUSH SWITCH
S523	ESP0001-007	PUSH SWITCH
S524	ESP0001-007	PUSH SWITCH
S525	ESP0001-007	PUSH SWITCH
	E302973-001	CIRCUIT BOARD

3-(4) TPS-320KBS Fuse P.C. Board Ass'y

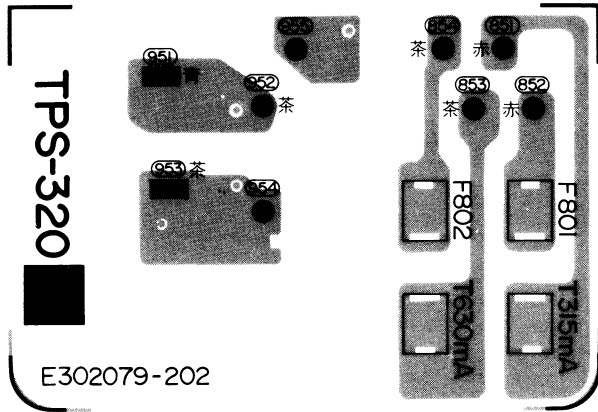

(for U.K. only)

ITEM	PART NUMBER	DESCRIPTION
	E302079-201BS	CIRCUIT BOARD
	E65508-002	TAB
	E43727-002	TAB
	EMG7331-001	FUSE CLIP

3-(5) TPS-320J Fuse P.C. Board Ass'y

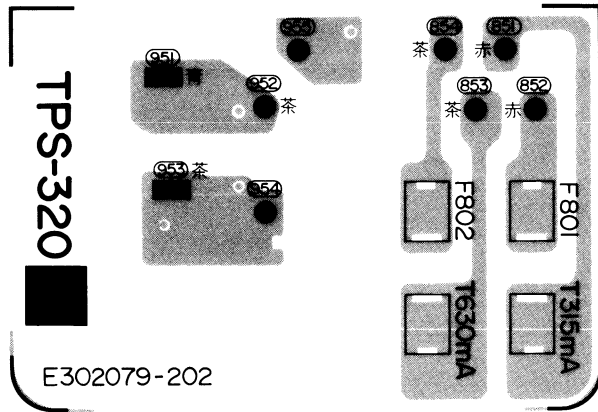

(Except for U.K.)

ITEM	PART NUMBER	DESCRIPTION
	E30279-201	CIRCUIT BOARD
	E65508-002	TAB
	E43727-002	TAB
	EMG7331-001	FUSE CLIP

3-(6) TPS-266C Voltage Selector P.C. Board Ass'y

(Except for U.S.A, Canada, Europe, Spain, West Germany, Australia, U.K.)

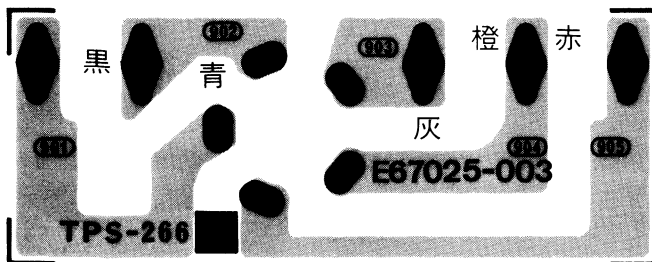

ITEM	PART NUMBER	DESCRIPTION
	QSR0074-001	VOLTAGE SELECTOR Δ
	E43727-002	TAB
	E67025-003	CIRCUIT BOARD
	E66342-001	VOLTAGE SELECTOR HOLDER

Δ Safety Parts

Note: The symbols (赤、黒、白 ...etc.) on P.C. Board surface are factory process only.

4. Packing Materials and Part Numbers

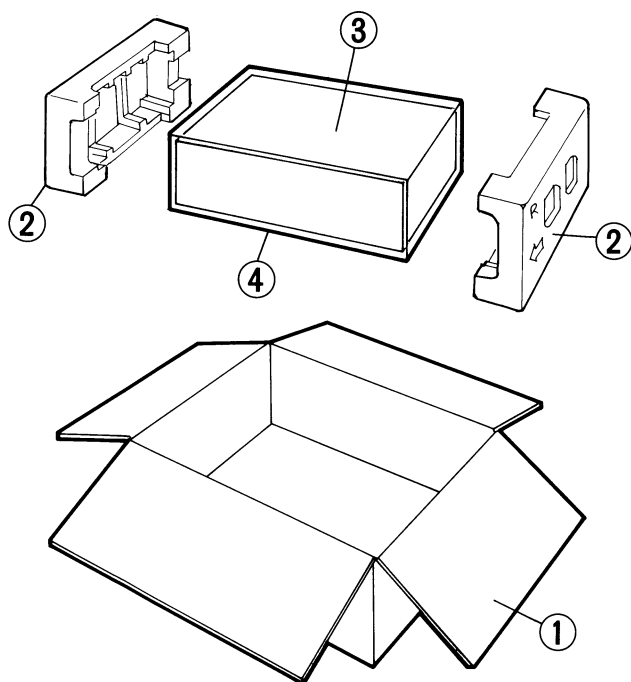

No.	Part Name	Part Number	Description
1	Packing Case	PK-TX900E(B) PK-TX900LE(B) PK-TX900LES(B)	J, C, P, PG, A, U LE, LES, LBS, LG LES
2	Fillers	NZ-TX900E	(L . . . E24559-001) (R . . . E24559-002)
3	Envelope	E34033-023	
4	Protect Sheet	E36997-046	

The Marks by Designated Area			
J	U.S.A.	LES	Spain
C	Canada	LG	West Germany
P, PG	U.S. Military, Market	A	Australia
LE	Europe	LBS	U.K.
		U	Other Countries

5. Accessories List

Part Name	Part Number	Area
Instruction Book	E30580-1154A	J, C, P, PG, A, LE, LES, LG, U
Warranty Card	E30580-1154ABS BT20048A BT20025F BT20029C	LBS J, P, PG C A
Instruction Sheet	BT20060	LBS
SVC Center	BT20064	LG
FTZ Information Sheet	BT20044D BT20071 BT20054-005A	J C LG
Service Information Card	BT20046B	J, P, PG
Siemens Plug	E04056	U, PG
Channel Sheet	E302974-003~006 E302974-007~012 E302974-013~014 E302974-015	J, C, P, PG, A, LE, LES, LG, U, LBS P, PG, A, LE, LES, LG, U, LBS J, C, P, PG, U LE, LG, LES, LBS
Caution Sheet(220V)	E70886-003 E60932-019	P, PG, A, LE, LES, LG, U, LBS PG, U
Caution Sheet(110V)	E60932-017	P
Envelope(for Instruction Book)	E41202-2	J, C, P, PG, A, LE, LES, LG, U
Envelope(for Warranty Card)	E41202-2B E66416-003	LBS J